



LIPPERT COMPONENTS, INC.

Towable RV Component Manual

THE DOCUMENTS PROVIDED IN THE LIPPERT COMPONENTS, INC. TOWABLE RV COMPONENT MANUAL ARE DESIGNED AS A GENERAL OVERVIEW OF SYSTEMS THAT MAY BE INSTALLED ON YOUR TRAILER OR 5TH WHEEL.

THE INTENT OF THIS DOCUMENT IS TO PROVIDE THE CONSUMER BASIC INFORMATION ABOUT THE SYSTEMS OR COMPONENTS LCI PROVIDES TO THE MANUFACTURER OF YOUR UNIT.

THE INFORMATION IS NOT INTENDED AS A COMPREHENSIVE TOOL FOR COMPLETE TROUBLESHOOTING OR DIAGNOSIS OF ANY ISSUE YOU MAY BE EXPERIENCING WITH YOUR UNIT.

FOR MORE COMPREHENSIVE INFORMATION ON THESE AND OTHER SYSTEMS, COMPONENTS AND PRODUCTS OFFERED BY LCI, PLEASE VISIT OUR WEBSITE, www.lci1.com AND CLICK ON THE "**SUPPORT**" TAB. TO PURCHASE AFTERMARKET PARTS CLICK ON THE "**STORE**" TAB.

PLEASE CONSULT THE MANUFACTURER OF YOUR UNIT, YOUR SELLING DEALER OR LIPPERT COMPONENTS DIRECTLY FOR ANY ISSUES THAT NEED TO BE PROFESSIONALLY ADDRESSED.

**PLEASE FEEL FREE TO CONSULT
LIPPERT COMPONENTS, INC. CUSTOMER SERVICE:
PHONE - (574)537-8900 E-MAIL - warranty@lci1.com**

**Be sure to check out the many YouTube component videos
located on our website, www.lci1.com.
Just click on the LCI-TV link at the top of the page.**

***TOWABLE RV COMPONENT MANUAL*****TABLE OF CONTENTS**

| | |
|--|----|
| SLIDEOUTS | |
| SCHWINTEK INWALL SLIDEOUT SYSTEM..... | 1 |
| ABOVE FLOOR SLIDEOUT SYSTEM..... | 5 |
| ELECTRIC SLIDEOUT SYSTEM-THROUGH FRAME..... | 7 |
| HYDRAULIC SLIDEOUT SYSTEM-THROUGH FRAME..... | 10 |
| JACKS & LEVELING | |
| HYDRAULIC LANDING GEAR..... | 13 |
| ELECTRIC STABILIZER JACK..... | 16 |
| ELECTRIC TONGUE JACK..... | 17 |
| LEVEL-UP WITH AUTOMATIC LEVELING..... | 18 |
| LEVEL-UP MANUAL OVERRIDE PROCEDURE- SEE DVD..... | 22 |
| GROUND CONTROL - ELECTRIC LEVELING..... | 23 |
| AXLE AND CHASSIS | |
| TRAILER AXLE..... | 27 |
| LCI CHASSIS INFORMATION..... | 36 |
| DOORS | |
| ENTRY DOOR LATCH - FASTEC, INC.- MANUAL ENTRY..... | 37 |
| ENTRY DOOR LATCH - SOUTHCO - KEYLESS ENTRY..... | 38 |
| GENERAL MAINTENANCE | |
| COMPONENT MAINTENANCE..... | 39 |
| LIPPERT COMPONENTS CUSTOMER SERVICE | |
| CONTACT INFORMATION..... | 40 |

IF YOU CANNOT FIND A PARTICULAR COMPONENT, SYSTEM OR PRODUCT IN THE DOCUMENTS LISTED ABOVE, PLEASE CONTACT LIPPERT BY PHONE OR E-MAIL OR CHECK OUT OUR WEBSITE, ALL LISTED BELOW.



SCHWINTEK IN-WALL SLIDEOUT SYSTEM

ERROR CODES

During operation when an error occurs the board will use the LED Lights to indicate where the problem exists.

For motor specific faults the green led will blink 1 time for motor 1, and 2 times for motor 2. The red led will blink from 2 to 9 times depending on the error code.

The error codes are as follows:

- 2 Battery drop out: Battery capacity low enough to drop below 6 volts while running
- 3 Low battery: Voltage below 8 volts at start of cycle
- 4 High battery: Voltage greater than 18 volts
- 5 Excessive motor current: High amperage, also indicated by 1 side of slide continually stalling.
- 6 Motor short circuit: Motor or wiring to motor has shorted out.
- 8 Hall signal not present: Encoder is not providing a signal usually indicates a wiring problem.
- 9 Hall power short to ground: Power to encoder has been shorted to ground. Usually a wiring problem.

When an error code is present, the board needs to be reset. Energizing the extend/retract switch resets the board. Energize the extend/retract switch again for normal operation.



NOTE: CONTROLLER MODEL I.D. NUMBER. THIS PICTURE SHOWN AS EXAMPLE ONLY. YOU MAY HAVE A DIFFERENT MODEL INSTALLED.

WARNING!

DO NOT MOVE THE RV UNLESS THE MOTORS ARE PLUGGED IN!

Manual Override - C1 & C2 versions

1. Electronic Manual Override (available on board revision C1 and newer)

Locate the circuit board.

Press the "mode button" six times quickly, press a 7th time and hold for approximately 5 seconds.

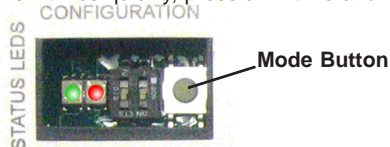

The red and green LED lights will begin to flash, confirming the override mode. Release mode button.

Back inside coach; use the normal slide control switch to retract the room.

A video demonstrating this technique can be found on the internet.

Follow this link: <http://www.youtube.com/watch?v=ymt1Uesf0Pc>

2. Manually push room in override.

Locate the circuit board.

Unplug both motors from circuit board, (releases motor brake).



Push or pull slide room in as desired; larger rooms may require several people to push. Keep both sides of room relatively even.

When room is completely in, plug both motors back in to the control board. (This applies brake for road travel.)

3. Disengage motors, manually retract room and travel lock.

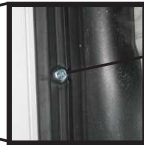

Motor Retention Screw

Locate and remove motor retention screw located near top of each vertical column.



Bend back wipe seal and visually locate motor

1/2"

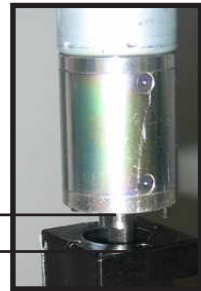

Pull the motor up until disengaged, about 1/2"

Repeat this process for both sides of slide room.

Push or pull room back into opening, keep both sides relatively even.

The room must be travel locked to keep room in place for road travel.

A video demonstrating this technique can be found on the internet.

Follow this link <http://www.youtube.com/watch?v=ymt1Uesf0Pc>

TROUBLESHOOTING FLOW CHART

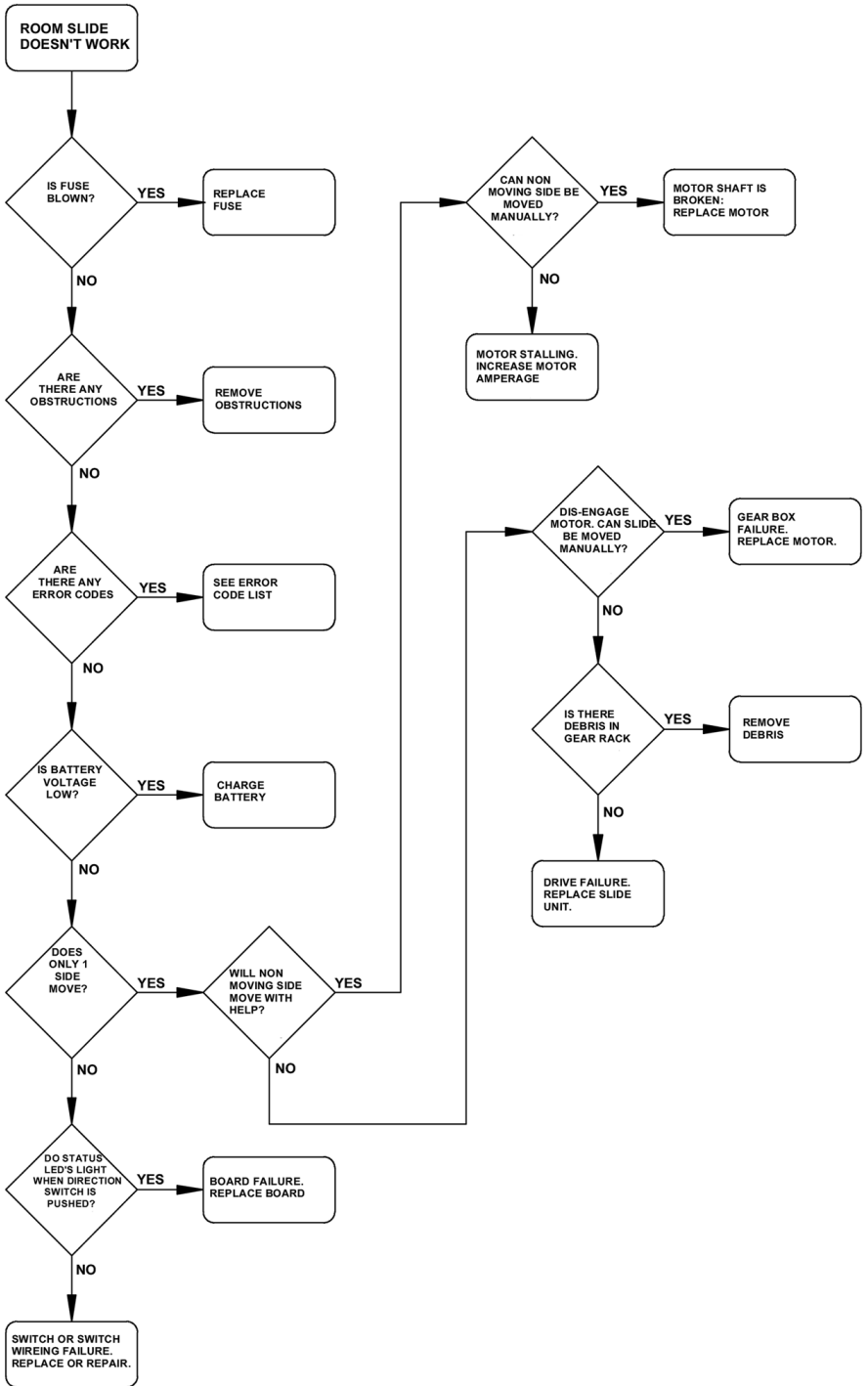

Checking Fuses

The Schwintek Inwall Slide requires a minimum of a 30 amp fuse. Check the 12 volt fuse box for blown fuses, and replace any if necessary. Consult the RV manufacturers documentation for the location of the 12 volt fuse box, and the location of the room slide controller's fuse. If the fuse blows immediately upon replacement, there is a problem with the wiring to the in-wall slide control box. Have qualified service personnel check and repair.

Obstructions

Check outside the RV for possible obstructions: tree, post, car, etc... Check inside the RV for any obstructions: luggage, furniture, open cabinets, etc... Also check for smaller objects that may be wedged under the floor or in the sides of the unit. Remove obstructions before proceeding.

Error Codes

Consult RV manufacturer's documentation for the location of the inwall slide controller. See page 1 for a description of the error codes, and possible problems.

Low Voltage

The Schwintek Inwall Slide Controller is capable of operating the room with as little as 8 volts. But at these lower voltages the amperage requirement is greater. Check voltage at the controller. If voltage is lower than 11 volts, it is recommended that the battery be placed on a charger until it is fully charged. It may be possible to "jump" the RV's battery temporarily to extend or retract the room. Consult the RV manufacturer's owners manual on the procedure for 'jumping' or charging the battery.

*******Never 'jump' or charge the battery from the power connections on the in-wall controller. Always do this at the battery.*******

Only 1 side moving

The Schwintek Inwall Room Slide has a separate motor to operate each side of the room. Does only 1 side of the room move a short distance (2 to 4 inches) and stop?

Will non moving side move with help?

If only 1 side of the room is moving, then with someone's assistance press the switch to extend or retract the room while pushing the non moving side in the appropriate direction. On larger rooms it may be necessary to have two (2) or more people pushing the room.

Non-moving side moved manually

Try to push the non-moving side in and out. If a motor shaft has broken then it will be possible to move that side of the room several inches by hand. Larger rooms may require several people to push.

Debris in the rack

Check all four (4) gear racks on the side of the room for debris.

Do status LED's light?

Consult the rv manufacturers documentation for the location of the room slide controller. When the room slide direction switch is actuated, do the status LED's light up. Check this in both the extend and retract modes.



ABOVE FLOOR SLIDEOUT SYSTEM

WARNING!

FAILURE TO ACT IN ACCORDANCE WITH THE FOLLOWING MAY RESULT IN SERIOUS PERSONAL INJURY OR DEATH.

The *Lippert Above Floor Slideout System* is intended for the sole purpose of extending and retracting the slideout room. Its function should not be used for any other purpose or reason than to actuate the slideout room. To use the system for any reason other than what it is designed for may result in damage to the coach and/or cause serious injury or even death.

Before actuating the system, please keep these things in mind:

1. Parking locations should be clear of obstructions that may cause damage when the slideout room is actuated.
2. Be sure all persons are clear of the coach prior to the slideout room actuation.
3. Keep hands and other body parts away from slideout mechanisms during actuation. Severe injury or death may result.
4. To optimize slideout actuation, park coach on solid and level ground.

DESCRIPTION

The *Lippert Above Floor Slideout System* is a rack and pinion style slide system. Utilizing a bi-directional electric motor to actuate the drive shaft, the slideout room is extended and retracted from the same source. The actuator has a built-in automatic braking feature. The *Lippert Above Floor Slideout System* is designed as a negative or positive ground system.

There are no serviceable parts within the electric motor. If the motor fails, it must be replaced.

Disassembly of the motor voids the warranty.

Mechanical portions of the slideout system are replaceable. Contact Lippert Components, Inc. to obtain replacement parts.

PRIOR TO OPERATION

Prior to operating the *Lippert Above Floor Slideout System*, follow these four (4) guidelines:

1. Coach should be parked on the most level surface available.
2. Leveling or stabilizing system should be actuated to ensure coach will not move during operation of Slideout System.
3. Be sure battery is fully charged.
4. Be sure to keep all persons and pets clear of Slideout System during operation.

OPERATING SYSTEM

WARNING!

FAILURE TO ACT IN ACCORDANCE WITH THE FOLLOWING MAY RESULT IN SERIOUS PERSONAL INJURY OR DEATH.

ALWAYS MAKE SURE THAT THE SLIDEOUT ROOM PATH IS CLEAR OF PEOPLE AND OBJECTS BEFORE AND DURING OPERATION OF THE SLIDEOUT ROOM.

ALWAYS KEEP AWAY FROM THE SLIDE RAILS WHEN THE ROOM IS BEING OPERATED. THE GEAR ASSEMBLY MAY PINCH OR CATCH ON LOOSE CLOTHING CAUSING PERSONAL INJURY.

KEEP STORED ITEMS IN COMPARTMENT CLEAR OF SLIDEOUT MOTOR, MECHANISMS AND WIRING TO PREVENT INTERFERENCE OF SLIDEOUT OPERATION.

INSTALL TRANSIT BARS (IF SO EQUIPPED) ON THE SLIDEOUT ROOM DURING STORAGE AND TRANSPORTATION.

The family of *Lippert Above Floor Sofa Slide Systems* is controlled by a switch mounted on the coach wall, normally located close to the entry door.

EXTENDING SLIDEOUT ROOM

1. Level unit.
2. Verify the battery is fully charged and hooked up to the electrical system.
3. Remove transit bars (if so equipped).
4. Press and hold the IN/OUT switch in the OUT position until room is fully extended and stops moving.
5. Release switch, which will lock the room into position.

NOTE: Only hold OUT switch until room stops.

RETRACTING SLIDE-OUT ROOM

1. Verify the battery is fully charged and hooked up to the electrical system.
2. Press and hold the IN/OUT switch in the IN position until the room is fully retracted and stops moving.
3. Release the switch. This will lock the room into position.

NOTE: Only hold IN switch until room stops.

4. Install the transit bars (if so equipped).

MANUAL OPERATION

The *Lippert Above Floor Slideout System Motor* is equipped with a manual override system that allows you to extend or retract a room if the rooms do not move when switch is pushed.

WARNING!

ALWAYS DISCONNECT THE BATTERY FROM SYSTEM PRIOR TO MANUALLY OPERATING SYSTEM. FAILURE TO DISCONNECT THE BATTERY CAN CAUSE ELECTRICITY TO BACKFEED THROUGH THE MOTOR AND CAUSE SERIOUS DAMAGE TO THE SYSTEM AS WELL AS VOID THE WARRANTY.

THE GEARS CAN BE STRIPPED OUT IF THE ROOM IS MANUALLY RETRACTED/EXTENDED TO IT'S FULLEST EXTENT AND THE OPERATOR CONTINUES TO ROTATE MANUAL OVERRIDE. ANY DAMAGE DUE TO MISUSE OF THE MANUAL OVERRIDE FEATURE WILL DISQUALIFY ANY AND ALL CLAIMS TO THE LIMITED WARRANTY.

1. With a second person assisting, one person must push and hold the MANUAL OVERRIDE switch in the unit, if applicable, located on the control panel, while the other person, using a 5/8" wrench or socket/ratchet combination, rotates the hex head MANUAL OVERRIDE to manually move the slideout.

PREVENTATIVE MAINTENANCE

The *Lippert Above Floor Slideout System* has been designed to require very little maintenance and has been static tested to over 2,500 continuous cycles with out any noticeable wear to rotating or sliding parts. No grease or lubrication is necessary and in some situations may be detrimental to the environment and long term dependability of the system. To ensure the long life of your slideout system, read and follow these few simple procedures.

ELECTRICAL SYSTEM MAINTENANCE

For optimum performance, slideout system requires full battery current and voltage. The battery must be maintained at full capacity. Other than good battery maintenance, check the terminals and other connections at the battery, the control switch, and the electric motor for corrosion, and loose or damaged terminals. Check motor leads under the motorhome chassis. Since these connections are subject to damage from road debris, be sure they are in good condition.

NOTE: The *Lippert Above Floor Slideout System* is designed to operate as a negative ground system. a 12V DC system must maintain good wire connections. It is important that the electrical components have good ground connection. Over 90% of unit electrical problems are due to bad ground connections.

MECHANICAL MAINTENANCE

Although the system is designed to be almost maintenance free, inspect the slideout for any visible signs of external damage after and before movement of the room. Remember to inspect inside the coach as well as the slideout system outside the coach.

PHONE: (574)537-8900

E-MAIL: warranty@lci1.com

WEB: www.lci1.com



ELECTRIC SLIDEOUT SYSTEM - THROUGH FRAME

WARNING!

FAILURE TO ACT IN ACCORDANCE WITH THE FOLLOWING MAY RESULT IN SERIOUS PERSONAL INJURY OR DEATH.

The *Lippert Electric Slideout System* is intended for the sole purpose of extending and retracting the slideout room. Its function should not be used for any other purpose or reason than to actuate the slideout room. To use the system for any reason other than what it is designed for may result in damage to the coach and/or cause serious injury or even death.

Before actuating the system, please keep these things in mind:

1. Parking locations should be clear of obstructions that may cause damage when the slideout room is actuated.
2. Be sure all persons are clear of the coach prior to the slideout room actuation.
3. Keep hands and other body parts away from slideout mechanisms during actuation. Severe injury or death may result.
4. To optimize slideout actuation, park coach on solid and level ground.

DESCRIPTION

The *Lippert Electric Slideout System* is a rack & pinion guide system, utilizing an electric ball screw actuator to move the room assembly. The motor drives the ball screw in a forward and backward motion to drive the slide room in and out. The actuator comes equipped with an automatic clutching system. The *Lippert Electric Slideout System* is designed to operate as a negative ground system.

SPECIAL NOTE - IF YOU HAVE A WELD-ON 2 x 2 SYSTEM:

The *Lippert 2 x 2 Slideout System* has three basic assemblies:

1. **Outer Rail** – Angled flange is welded to frame of coach. Flange runs from approximately halfway forward of the inside end of the outer rail to outer edge of Gear Drive Assembly.
2. **Inner Rail** - Inner Rail rides inside outer rail and is actuated by the rack gear welded to the bottom of the rail and the pinion gear in the Gear Drive Assembly. Mounting Plate on the outside end of the inner rail is bolted to the slideout room and is slotted for room adjustment.
3. **Gear Drive** – Houses drive shaft and pinion gear. 12V DC motor attaches to drive shaft to actuate system.

PRIOR TO OPERATING THE LIPPERT ELECTRIC SLIDEOUT SYSTEM, FOLLOW THESE GUIDELINES:

1. Coach should be parked on the most level surface available.
2. Leveling or stabilizing system should be actuated to ensure coach will not move during operation of Slideout System.
3. Be sure battery is fully charged.
4. Be sure to keep all persons and pets clear of Slideout System during operation.

SYSTEM MAINTENANCE

The *Lippert Electric Slideout System* has been static tested to over 4,000 continuous cycles with out any noticeable wear to rotating or sliding parts. It is recommended that when operating in harsh environments (road salt, ice build up, etc.) the moving parts be kept clean and can be washed with mild soap and water. No grease or lubrication is necessary and in some situations may be detrimental to the environment and long term dependability of the system.

ELECTRICAL SYSTEM MAINTENANCE

For optimum performance, the slide-out system requires full battery current and voltage. The battery must be maintained at full capacity. Other than good battery maintenance, check the terminals and other connections at the battery, the control switch, and the electric actuator motor for corrosion, and loose or damaged terminals. Check motor leads under the trailer chassis. Since these connections are subject to damage from road debris, be sure they are in good condition.

NOTE: The *Lippert Electric Slideout System* is designed to operate as a negative ground system. A negative ground system utilizes the chassis frame as a ground and an independent ground wire back to battery is necessary. It is important that the electrical components have good wire to chassis contact. Over 90% of unit electrical problems are due to bad ground connections.

MECHANICAL MAINTENANCE

Although the system is designed to be almost maintenance free, actuate the room once or twice a month to keep the seals and internal moving parts lubricated. Check for any visible signs of external damage after and before movement of the travel trailer.

NOTE: *For long-term storage: It is recommend that the room be closed (retracted).* **WARNING!** FAILURE TO ACT IN ACCORDANCE WITH THE FOLLOWING MAY RESULT IN SERIOUS PERSONAL INJURY OR DEATH.

ALWAYS MAKE SURE THAT THE SLIDEOUT ROOM PATH IS CLEAR OF PEOPLE AND OBJECTS BEFORE AND DURING OPERATION OF THE SLIDEOUT ROOM.

ALWAYS KEEP AWAY FROM THE SLIDE RAILS WHEN THE ROOM IS BEING OPERATED. THE GEAR ASSEMBLY MAY PINCH OR CATCH ON LOOSE CLOTHING CAUSING PERSONAL INJURY.

INSTALL TRANSIT BARS (IF SO EQUIPPED) ON THE SLIDEOUT ROOM DURING STORAGE AND TRANSPORTATION.

EXTENDING SLIDEOUT ROOM

1. Level the unit.
2. Verify the battery is fully charged and hooked-up to the electrical system.
3. Remove the transit bars (if so equipped).
4. Press and hold the IN/OUT switch in the OUT position until the room is fully extended and stops moving.
5. Release the switch, which will lock the room into position.

NOTE: If the slideout switch is held after the room is fully extended, the control will sense that the room has stopped and will shut off the motor after a few seconds.

RETRACTING SLIDEOUT ROOM

1. Verify the battery is fully charged and hooked-up to the electrical system.
2. Press and hold the IN/OUT switch in the IN position until the room is fully retracted and stops moving.
3. Release the switch, which will lock the room into position.

NOTE: If the slideout switch is held after the room is fully retracted, the control will sense that the room has stopped and will shut off the motor after a few seconds.

4. Install the transit bars (if so equipped).

MANUAL OPERATION

The Lippert electric slide comes with a manual override system. Locate the crank extension with pin outside of the chassis main rail or underneath the unit on the end of the motor. Simply take the crank handle and rotate it clockwise to retract and counterclockwise to extend slideout. It is important to note that you DO NOT need to attempt to disengage the motor as the actuator is "manual ready". Just hook up and crank. Use EXTREME CAUTION when extending and/or retracting room using the manual override feature. It is possible to operate the slideout beyond the maximum extension and/or retraction and damage the slide components, slide room structure or trim components.

SERVICE

Mechanical Room Adjustment

Vertical & Horizontal Room Adjustment

NOTE: All slideout room adjustments must be performed by certified service technicians. Adjustments made by non-certified persons may void any and all warranty claims.

Horizontal adjustment

1. Loosen 2 carriage bolts "A" on each bracket located at the end of each guide tube.
2. Room is ready to be positioned horizontally by pushing on the outside, sidewall or by using a prying devise inserted into the opening between the room and coach.

NOTE: Use caution when using prying devise so seals do not become damaged.

Vertical adjustment

1. Loosen 2 carriage bolts "A" on each bracket located at the end of each guide tube
2. Loosen jam nut
3. For vertical adjustment turn vertical adjustment bolt "B" up or down to locate room height.

NOTE: Once room is located, tighten "A" and Jam Nut bolts.

ADJUSTING ROOM SO IT SEALS IN THE IN POSITION

1. Locate actuator coming through the frame
2. On the end of the actuator there is a threaded shaft mounted to the drive bracket with 3 nuts and a stop can.
3. Loosen the $\frac{3}{4}$ " nut (Jam Nut-1) on the outside of the stop can.
4. Screw the can out or in, and then tighten down the nut – this will change the location of your seal going to the "in position."

ADJUSTING ROOM SO IT SEALS IN THE OUT POSITION:

1. Locate actuator coming through the frame.
2. On the end of the actuator there is a threaded shaft mounted to the bracket with 3 nuts and a stop can.
3. Move one of the 1" nuts (Jam Nut-2 or Nylock Nut) one way or the other– this will change the location of your seal going to the "out position."
4. Make sure all nuts are tight.

SYNCHRONIZING ROOM TRAVEL

The *Lippert Electric Slideout System* room travel (both sides of the room traveling the same distance) can be adjusted with specially designed synchronizing bracket mounted on the passive slide tube. The passive slide tube is the one that is not powered. The active slide tube is the one that has the cylinder attached. If one side of the room fails to seal adjust as follows:

1. Loosen bolts on top of the passive slide tube.
2. Push or pull room (on the passive side) to align with the active side.

REMOVING AND REPLACING ACTUATOR

To replace actuator:

1. Disconnect manual crank shaft from end of motor assembly.
2. Disconnect motor wires from source.
3. Take measurements A and B.
4. Remove all jam nuts (3 total) and stop can from threaded shaft on actuator.
5. Take note of mounting bolt locations and remove mounting bolts.
6. After everything is disconnected, slide actuator out of frame. To replace with new actuator, follow previous directions in reverse.



HYDRAULIC SLIDEOUT SYSTEM - THROUGH FRAME

WARNING!

FAILURE TO ACT IN ACCORDANCE WITH THE FOLLOWING MAY RESULT IN SERIOUS PERSONAL INJURY OR DEATH.

THE LIPPERT HYDRAULIC SLIDEOUT SYSTEMS ARE INTENDED FOR THE PURPOSES OF EXTENDING AND RETRACTING THE SLIDEOUT ROOM. THE USE OF THESE SYSTEMS FOR ANY REASON OTHER THAN WHICH IT IS INTENDED IS PROHIBITED BY LIPPERT'S LIMITED WARRANTY AND MAY RESULT IN SERIOUS PERSONAL INJURY OR DEATH.

THE LIPPERT HYDRAULIC SLIDEOUT SYSTEMS ARE DESIGNED AS "SLIDEOUT" SYSTEMS AND SHOULD NOT BE USED TO PROVIDE SERVICE FOR ANY REASON.

BE SURE TO KEEP HANDS AND OTHER BODY PARTS CLEAR OF FLUID LEAKS. OIL LEAKS IN THE LIPPERT HYDRAULIC SLIDEOUT SYSTEMS MAY BE UNDER HIGH PRESSURE AND CAN CAUSE SERIOUS SKIN PENETRATING INJURIES.

PRIOR TO OPERATION

The leveling system shall only be operated under the following conditions:

1. The coach is parked on a reasonably level surface.
2. Be sure all person, pets, and property are clear of the coach while Lippert Hydraulic Slideout Systems are in operation.
3. Unit must be leveled prior to extending the slideouts to ensure coach will not move during operation of slideout system and to provide the unit with a firm foundation.
4. Be sure battery is fully charged.

PREVENTATIVE MAINTENANCE PROCEDURES

The Lippert Hydraulic Slideout Systems have been designed to require very little maintenance. To ensure the long life of your system, read and follow these few simple procedures.

1. Change fluid every 36 months. (In reservoir ONLY!)
 - a) Check fluid only when jacks and slideouts are fully retracted.
 - b) Always fill the reservoir when the slideouts are in the fully retracted position. Filling reservoir when slideouts are extended will cause reservoir to overflow into its compartment when slideouts are retracted.
 - c) When checking fluid level, fluid should be within 1/4" of fill spout lip.
2. Check the fluid level every month.
3. Inspect and clean all pump unit electrical connections on the pump unit every 12 months.
4. Remove dirt and road debris from slideout arms and cylinders as needed.

WARNING!

Your coach should be supported at both front and rear axles with jack stands before working underneath. Failure to do so may result in personal injury or death.

5. If slideouts are extended for lengthy periods, it is recommended to spray exposed cylinder rods with a silicone lubricant every seven days for protection. If your coach is located in a salty environment, it is recommended to spray the rods every two (2) to three (3) days.

WARNING!

DO NOT WORK ON YOUR SLIDEOUT SYSTEM UNLESS THE BATTERY IS DISCONNECTED. FAILURE TO ACT IN ACCORDANCE WITH THE FOLLOWING MAY RESULT IN SERIOUS PERSONAL INJURY OR DEATH.

EXTENDING SLIDEOUT ROOM

1. Level the unit.
2. Verify the battery is fully charged and hooked-up to the electrical system.
3. Remove the transit bars (if so equipped).
4. Press and hold the IN/OUT switch in the OUT position until the room is fully extended and stops moving.
5. Release the switch, which will lock the room into position.

RETRACTING SLIDEOUT ROOM

1. Verify the battery is fully charged and hooked-up to the electrical system.
2. Press and hold the IN/OUT switch in the IN position until the room is fully retracted and stops moving.
3. Release the switch, which will lock the room into position.

NOTE: If the slideout switch is held after the room is fully retracted, the control will sense that the room has stopped and will shut off the motor after a few seconds.

4. Install the transit bars (if so equipped).

OPERATION-HYDRAULIC SLIDEOUT

WARNING!

FAILURE TO ACT IN ACCORDANCE WITH THE FOLLOWING MAY RESULT IN SERIOUS PERSONAL INJURY OR DEATH.

ALWAYS MAKE SURE THAT THE SLIDEOUT ROOM PATH IS CLEAR OF PEOPLE AND OBJECTS BEFORE AND DURING OPERATION OF THE SLIDEOUT ROOM.

ALWAYS KEEP AWAY FROM THE SLIDE RAILS WHEN THE ROOM IS BEING OPERATED. THE GEAR ASSEMBLY MAY PINCH OR CATCH ON LOOSE CLOTHING CAUSING PERSONAL INJURY.

INSTALL TRANSIT BARS (IF SO EQUIPPED) ON THE SLIDEOUT ROOM DURING STORAGE AND TRANSPORTATION.

SYSTEM MAINTENANCE

The Lippert Hydraulic Slideout and HLG System has been static tested to over 6,000 continuous cycles without any noticeable wear to rotating or sliding parts. It is recommended that when operating in harsh environments (road salt, ice build up, etc.) the moving parts be kept clean and can be washed with mild soap and water. No grease or lubrication is necessary and in some situations may be detrimental to the environment and long term dependability of the system.

ELECTRICAL SYSTEM MAINTENANCE

For optimum performance, the system requires full battery current and voltage. The battery must be maintained at full capacity. Other than good battery maintenance, check the terminals and other connections at the battery, the control switch, and the electric actuator motor for corrosion, and loose or damaged terminals. Check motor leads under the trailer chassis. Since these connections are subject to damage from road debris, be sure they are in good condition.

MECHANICAL SYSTEM MAINTENANCE

Although the system is designed to be almost maintenance free, actuate the slideouts and jacks once or twice a month to keep the seals and internal moving parts lubricated. Check for any visible signs of external damage or "leakage" before and after movement of the unit.

When the room is out, visually inspect the inner and outer assemblies of the slideout. Also inspect around the shoe of the leveling jacks for signs of leakage. Check for excess build-up of dirt or other foreign material; remove any debris that may be present.

If the system squeaks or makes any noises it is permissible to apply a coat of lightweight oil to the drive shaft and roller areas of the slideout only but remove any excess oil so dirt and debris do not build-up. DO NOT use grease.

NOTE: For long-term storage: It is recommend that the room be closed (retracted).

NOTE: The Lippert Hydraulic Slideout Systems are designed to operate as a negative ground system. A negative ground system utilizes the chassis frame as the ground source. An independent ground wire back to the battery is not needed. It is important the electrical components have good wire to chassis contact. Over 90% of unit electrical problems can be attributed to bad ground connections.

NOTE: For long-term storage: It is recommended that the room be closed (retracted) and if your unit is equipped with the IRC room control, it is recommended all of the control knobs be kept in the closed position.

FILLING DIRECTIONS

The Lippert Hydraulic Slideout Systems uses automatic transmission fluid (ATF). Any ATF can be used. A full synthetic or synthetic blend works best such as Dexron II, Dexron III or Mercon 5. For best operation, fill system within 1/4" of the top when all slideouts and landing gear are completely retracted. The see-through reservoir makes it easy to check oil level. It is recommended that the oil level be checked prior to operating the system. Make sure the breather cap is free of contamination before removing, replacing or installing. In colder temperatures (less than 10° F) the cylinders and jacks may extend and retract slowly due to the fluid's molecular nature. For cold weather operation, fluid specially formulated for low temperatures may be desirable.

Please consult factory before using any other fluids.

1. Remove Breather/Fill Cap
2. Pour ATF into Breather/Fill opening.

NOTE: Do not allow any contamination into reservoir during fill process.

NOTE: Standard reservoir holds approximately 2 quarts (1.89 liters) of ATF.

3. Fill to within 1/4" of top.
4. Replace Breather/Fill cap when finished.

MANUAL OVERRIDE - POWER SYSTEM

The Lippert Hydraulic Slideout Systems can be run with auxiliary power devices like electric drills, ratchet wrenches or cordless screwdrivers. In the event of electrical or system failure, this manual method of extending and retracting the jacks can be used. A standard handheld drill is all that is required. See the instructions below.

1. Remove protective label.
2. Using a standard hex bit, insert into auxiliary drive device, i.e. cordless drill or screwdriver or ratchet wrench.
3. Insert hex bit into coupler found under protective label.
4. Run drill forward or clockwise to extend jacks and in reverse or counterclockwise to retract jacks.

MECHANICAL ROOM ADJUSTMENT

Vertical & Horizontal Room Adjustment

NOTE: All slideout room adjustments must be performed by certified service technicians. Adjustments made by non-certified persons may void any and all warranty claims.

Horizontal adjustment

1. Loosen 2 carriage bolts "A" on each bracket located at the end of each guide tube.
2. Room is ready to be positioned horizontally by pushing on the outside, sidewall or by using a prying devise inserted into the opening between the room and coach.

NOTE: Use caution when using prying devise so seals do not become damaged.

Vertical adjustment

1. Loosen 2 carriage bolts "A" on each bracket located at the end of each guide tube
2. Loosen jam nut
3. For vertical adjustment turn vertical adjustment bolt "B" up or down to locate room height. Once room is located, tighten "A" and Jam Nut bolts.



HYDRAULIC LANDING GEAR

WARNING!

FAILURE TO ACT IN ACCORDANCE WITH THE FOLLOWING MAY RESULT IN SERIOUS PERSONAL INJURY OR DEATH.

THE USE OF THE LIPPERT HYDRAULIC LANDING GEAR TO SUPPORT THE COACH FOR ANY REASON OTHER THAN WHICH IT IS INTENDED IS PROHIBITED BY LIPPERT'S LIMITED WARRANTY. THE LIPPERT LANDING GEAR SYSTEM IS DESIGNED AS A "LANDING GEAR" SYSTEM ONLY AND SHOULD NOT BE USED TO PROVIDE SERVICE FOR ANY REASON UNDER THE COACH SUCH AS CHANGING TIRES OR SERVICING THE LEVELING SYSTEM.

LIPPERT COMPONENTS, INC. RECOMMENDS THAT A TRAINED PROFESSIONAL BE EMPLOYED TO CHANGE THE TIRE ON THE COACH. ANY ATTEMPTS TO CHANGE TIRES OR PERFORM OTHER SERVICE WHILE COACH IS SUPPORTED BY THE LIPPERT HYDRAULIC LANDING GEAR COULD RESULT IN DAMAGE TO THE COACH AND/OR CAUSE SERIOUS PERSONAL INJURY OR DEATH.

- BE SURE TO PARK THE COACH ON SOLID, LEVEL GROUND.
- CLEAR ALL JACK LANDING LOCATIONS OF DEBRIS AND OBSTRUCTIONS. LOCATIONS SHOULD ALSO BE FREE OF DEPRESSIONS.
- WHEN PARKING THE COACH ON EXTREMELY SOFT SURFACES, UTILIZE LOAD DISTRIBUTION PADS UNDER EACH JACK.
- PEOPLE AND PETS SHOULD BE CLEAR OF COACH WHILE OPERATING LEVELING SYSTEM.
- BE SURE TO KEEP HANDS AND OTHER BODY PARTS CLEAR OF FLUID LEAKS. OIL LEAKS IN THE LIPPERT HYDRAULIC LANDING GEAR MAY BE UNDER HIGH PRESSURE AND CAN CAUSE SERIOUS SKIN PENETRATING INJURIES.
- NEVER LIFT THE COACH COMPLETELY OFF THE GROUND. LIFTING THE COACH SO THE WHEELS ARE NOT TOUCHING GROUND WILL CREATE AN UNSTABLE AND UNSAFE CONDITION.

PRIOR TO OPERATION

The leveling system shall only be operated under the following conditions:

1. The unit is parked on a reasonably level surface.
2. The towing vehicle is disengaged from the unit.
3. Be sure all persons, pets, and property are clear of the coach while Lippert Landing Gear System is in operation.

SYSTEM DESCRIPTION

- Please read and study the operating manual before you operate the leveling system.
- The Lippert Hydraulic Landing Gear is an electric/hydraulic system. A 12V DC electric motor drives a hydraulic pump that moves fluid through a system of hoses, fittings, and jacks to level and stabilize the coach.
- There are no serviceable parts within the electric motor. If the motor fails, it must be replaced.
- Disassembly of the motor voids the warranty.
- Mechanical portions of the Lippert Hydraulic Landing Gear are replaceable. Contact Lippert Components, Inc. to obtain replacement parts.

COMPONENT DESCRIPTION

The Lippert Hydraulic Landing Gear consists of the following major components:

- Lippert Landing Gear are rated at a lifting capacity appropriate for your coach.
- Each landing gear is powered from a central 12VDC motor/pump assembly, which also includes the hydraulic oil reservoir tank, control valve manifold, and solenoid valves.
- The Lippert Hydraulic Landing Gear is controlled electronically from the switch near the pump.

PREVENTATIVE MAINTENANCE PROCEDURES

The Lippert Hydraulic Landing Gear has been designed to require very little maintenance. To ensure the long life of your slideout system, read and follow these few simple procedures.

1. Change fluid every 36 months.
 - a) Check fluid only when jacks are fully retracted.
 - b) Always fill the reservoir with the jacks in the fully retracted position. Filling reservoir when jacks are extended will cause reservoir to overflow into its compartment when jacks are retracted.
 - c) When checking fluid level, fluid should be within $\frac{1}{4}$ " of fill spout lip.
2. Check the fluid level every month.
3. Inspect and clean all pump unit electrical connections every 12 months.
4. Remove dirt and road debris from landing gear as needed.

WARNING!

Your coach should be supported at both front and rear axles with jack stands before working underneath. Failure to do so may result in personal injury or death.

5. If jacks are down for extended periods, it is recommended to spray exposed landing gear rod with a silicone lubricant every seven days for protection. If your coach is located in a salty environment, it is recommended to spray the rods every 2 to 3 days.

WARNING!

DO NOT WORK ON YOUR SLIDEOUT SYSTEM UNLESS THE BATTERY IS DISCONNECTED. FAILURE TO ACT IN ACCORDANCE WITH THE FOLLOWING MAY RESULT IN SERIOUS PERSONAL INJURY OR DEATH.

The Lippert Hydraulic Landing Gear has been static tested to over 6,000 continuous cycles without any noticeable wear to rotating or sliding parts. It is recommended that when operating in harsh environments and conditions (road salt, ice build-up, etc.) the moving parts be kept clean and can be washed with mild soap and water. No grease or lubrication is necessary and in some situations may be detrimental to the environment and long-term dependability of the system.

MECHANICAL COMPONENTS

Although the system is designed to be almost maintenance-free, actuate the landing gear once or twice a week to keep the seals and internal moving parts lubricated.

Check for any visible signs of "leaking" before and after movement of the system and the coach.

When the Landing Gear is down, visually inspect the inner and outer assemblies. Check for excess build-up of dirt or other foreign material; remove any debris that may be present.

If the system squeaks or makes any noises it is permissible to apply a coat of lightweight oil or silicone lubricant spray to the hydraulic rod, remove any excess oil so dirt and debris do not build-up. **DO NOT use grease.**

ELECTRICAL COMPONENTS

For optimum performance, the landing gear system requires full battery current and voltage. The battery must be maintained at full capacity. Other than good battery maintenance; check the terminals, other connections at the battery, the control switch, the pump motor for corrosion, loose or damaged terminals. Check motor leads under the coach chassis. Since these connections may be subject to damage from road debris, be sure they are in good condition.

NOTE: The Lippert Hydraulic Landing Gear is designed to operate as a negative ground system. A negative ground system utilizes the chassis frame as the ground source. An independent ground wire back to the battery is not needed. It is important the electrical components have good wire to chassis contact. Over 90% of unit electrical problems can be attributed to bad ground connections.

MANUAL OVERRIDE - POWER SYSTEM

The Lippert Hydraulic Landing Gear can be run with auxiliary power devices like electric drills, ratchet wrenches or cordless screwdrivers. In the event of electrical or system failure, this manual method of extending and retracting the jacks can be used. A standard handheld drill is all that is required. See the instructions below.

1. Remove protective label.
2. Using a standard hex bit, insert into auxiliary drive device, i.e. cordless drill or screwdriver or ratchet wrench.
3. Insert hex bit into coupler found under protective label.
4. Run drill forward or clockwise to extend jacks and in reverse or counterclockwise to retract jacks.

FILLING DIRECTIONS

The Lippert Hydraulic Landing Gear uses automatic transmission fluid (ATF). Any ATF can be used. A full synthetic or synthetic blend works best such as Dexron II, Dexron III or Mercon 5. For best operation, fill system within 1/4" of the top when all slideouts and landing gear are completely retracted. The see through reservoir makes it easy to check oil level. It is recommended that the oil level be checked prior to operating the system. Make sure the breather cap is free of contamination before removing, replacing or installing. In colder temperatures (less than 10° F) the cylinders and jacks may extend and retract slowly due to the fluid's molecular nature. For cold weather operation, fluid specially formulated for low temperatures may be desirable.

Please consult factory before using any other fluids.

1. Remove Breather/Fill Cap
 2. Pour ATF into Breather/Fill opening.
- NOTE:** Do not allow any contamination into reservoir during fill process.
- NOTE:** Standard reservoir holds approximately 2 quarts (1.89 liters) of ATF.
3. Fill to within 1/4" of top.
 4. Replace Breather/Fill cap when finished.



ELECTRIC STABILIZER JACK

Prior to Operation

The *Lippert Electric Stabilizer Jack* shall only be operated under the following conditions:

1. The unit is parked on a reasonably level surface.
2. Be sure all persons, pets and property are clear of the coach while *Lippert Electric Stabilizer Jack* is in operation.
3. Unit must be stabilized prior to extending the slideouts to ensure unit will not move during operation of slideout system (if so equipped); and to provide the unit with a firm foundation.
4. Be sure battery is fully charged.
5. NEVER attempt to LEVEL the unit with the *Lippert Electric Stabilizer Jack*. This jack is not meant to lift the weight of the towble unit. Damage incurred by attempting to level the towable unit with the *Lippert Electric Stabilizer Jack* will void the limited warranty.

OPERATION

WARNING!

FAILURE TO ACT IN ACCORDANCE WITH THE FOLLOWING MAY RESULT IN SERIOUS PERSONAL INJURY OR DEATH.

- ALWAYS MAKE SURE THAT THE *LIPPERT ELECTRIC STABILIZER JACK* PATH IS CLEAR OF PEOPLE AND OBJECTS BEFORE AND DURING OPERATION OF THE STABILIZER JACK.
- ALWAYS KEEP AWAY FROM THE STABILIZER JACK WHEN THE IT IS BEING OPERATED. THERE ARE AREAS THAT MAY PINCH OR CATCH ON LOOSE CLOTHING CAUSING PERSONAL INJURY.

EXTENDING STABILIZER JACK

1. Level the unit.
2. Verify the battery is fully charged and hooked-up to the electrical system.
3. Press and hold the RETRACT/EXTEND switch (Fig. 1) in the EXTEND (A) position until the stabilizer jack feet contact the ground, and unit is stabilized.
4. Release the switch.

RETRACTING STABILIZER JACK

1. Verify the battery is fully charged and hooked-up to the electrical system.
2. Press and hold the RETRACT/EXTEND switch in the retract position until the stabilizer jack is fully retracted.
3. Release the switch.

MANUAL OVERRIDE

The Lippert Electric Stabilizer Jack comes with a manual override system. Locate the manual override coupler on the end of the stabilizer jack opposite of the electric motor. To manually operate the stabilizer jack, one of the wire leads from the motor must be disconnected to prevent backloading the motor and causing more damage. Next, insert the 1/2" dia. crank handle inside the coupler. The slot in the end of the crank handle accomodates the pin inside the coupler to allow the manual extension/retraction of the stabilizer jack. Simply rotate the crank handle clockwise to retract and counterclockwise to extend stabilizer jack.

WARNING!

The drive gear can be stripped out if the stab jack if it is manually over-retracted or over-extended and the operator continues to rotate manual override handle. Any damage due to misuse of the Manual Override feature will disqualify any and all claims to the limited warranty.



ELECTRIC TONGUE JACK

IMPORTANT

Be sure to read and understand all instructions before installing, using or servicing this jack.

Be sure to read and understand all instructions provided by the trailer manufacturer that utilizes the jack. Lippert Components, Inc. is not responsible for improper installation, use or maintenance of the Electric Tongue Jack.

WARNINGS!

Disregarding warnings may result in property damage, serious bodily injury or death.

NEVER allow anyone unfamiliar with this product to install, operate or service this product.

NEVER lift or level this the trailer without a properly installed footpad.

NEVER crank jack or couple trailer without preventing the trailer from rolling

NEVER exert excessive side forces to the jack unit.

NEVER allow anyone, including operator to put any body parts under the jack, or the supported load during jack operation.

NEVER drop the trailer off the hitch ball.

NEVER exceed load capacity.

NEVER use jack to lift trailer for service or tire change.

NEVER move trailer before jack is fully retracted.

NEVER use jack unless footpad retaining pin is fully inserted through both sides of the jack's inner tube.

MANUAL OPERATION

If 12VDC power is unavailable to operate the Electric Tongue Jack use the following directions to manually operate the jack:

TO EXTEND

1. Start by chocking the trailer tires.
2. Be sure footpad (A) is pinned securely in place with clevis & hair pins (B).
3. Check ground surface under jack is firm and level.
4. Open rubber plug (C) on top of jack's gearbox to expose manual drive shaft
5. Insert manual crank handle (D).
6. Turn handle clockwise until trailer is supported and coupler clears hitch ball.
7. Move tow vehicle away from trailer.
8. Lower trailer until it is level by turning crank handle counterclockwise.
9. Remove crank handle.
10. Replace rubber plug.

TO RETRACT

1. Follow Steps 1 - 5 in the extend instructions.
2. Turn crank handle counterclockwise until coupler properly mounts hitch ball.
3. Be sure inner tube of jack is fully retracted prior to moving vehicle.
4. Follow Steps 9 - 10 in the extend instructions.

ELECTRIC OPERATION

TO EXTEND

1. Follow Steps 1 - 3 in the Manual Operation extend instructions.
2. Push EXT side of switch (E) to EXTEND jack until coupler clears hitch ball.
3. Follow steps 7 - 8.

TO RETRACT

1. Follow Steps 1 - 3 in the Manual Operation extend instructions.
2. Push RET side of switch (E) to RETRACT jack until coupler properly mounts hitch ball.
3. Be sure inner tube of jack is fully retracted prior to moving vehicle.

The Electric Tongue Jack is provided with a motor clutch. An OEM provided 30A fuse is located by following the RED OEM provided power wire beneath the jack and will need to be replaced if it blows. It must be replaced with a 30A ATO-type fuse. Battery must be fully charged, free of defect, and full of water prior to operating the jack. Low voltage from the battery will cause the fuse to blow prematurely.

The clutch will slip under two conditions: (1) the jack may have reached it's extend or retract limit or that the tongue weight of the trailer has exceeded the capacity limits of the jack. Items stored in the trailer can vastly influence the weight distribution of the jack. Reorganize stored items if electric tongue jack motor clutch continues to slip.

NOTE: The LCI Electric Tongue Jack has one wire coming from the motor. This wire must be connected to 12VDC.

WARNINGS!

- Release switch immediately when clutch noise occurs. The clutch is the overload protection for the motor. The clutch should not slip during normal operation. This will cause excessive wear on the clutch and the motor.
- If left on for extended periods of time, the courtesy light will drain the battery.
- The electric tongue jack is designed for jacking the trailer in a vertical position only.



LCI LEVEL-UP WITH AUTOMATIC LEVELING

WARNING!

FAILURE TO ACT IN ACCORDANCE WITH THE FOLLOWING MAY RESULT IN SERIOUS PERSONAL INJURY OR DEATH.

THE USE OF THE *LCI LEVEL-UP WITH AUTOMATIC LEVELING SYSTEM* TO SUPPORT THE UNIT FOR ANY REASON OTHER THAN WHICH IT IS INTENDED IS PROHIBITED BY LIPPERT'S LIMITED WARRANTY. THE LIPPERT LEVELING SYSTEM IS DESIGNED AS A "LEVELING" SYSTEM ONLY AND SHOULD NOT BE USED TO PROVIDE SERVICE FOR ANY REASON UNDER THE COACH SUCH AS CHANGING TIRES OR SERVICING THE LEVELING SYSTEM.

LIPPERT COMPONENTS, INC. RECOMMENDS THAT A TRAINED PROFESSIONAL BE EMPLOYED TO CHANGE THE TIRE ON THE UNIT. ANY ATTEMPTS TO CHANGE TIRES OR PERFORM OTHER SERVICE WHILE UNIT IS SUPPORTED BY THE *LCI LEVEL-UP WITH AUTOMATIC LEVELING SYSTEM* COULD RESULT IN DAMAGE TO THE 5TH WHEEL AND/OR CAUSE SERIOUS INJURY OR DEATH.

WARNINGS!

- > BE SURE TO PARK THE UNIT ON SOLID, LEVEL GROUND.**
 - > CLEAR ALL JACK LANDING LOCATIONS OF DEBRIS AND OBSTRUCTIONS. LOCATIONS SHOULD ALSO BE FREE OF DEPRESSIONS.**
 - > WHEN PARKING THE UNIT ON EXTREMELY SOFT SURFACES, UTILIZE LOAD DISTRIBUTION PADS UNDER EACH JACK.**
 - > PEOPLE AND PETS SHOULD BE CLEAR OF UNIT WHILE OPERATING LEVELING SYSTEM.**
 - > BE SURE TO KEEP HANDS AND OTHER BODY PARTS CLEAR OF FLUID LEAKS. OIL LEAKS IN THE LIPPERT LEVELING SYSTEM MAY BE UNDER HIGH PRESSURE AND CAN CAUSE SERIOUS SKIN PENETRATING INJURIES.**
 - > NEVER LIFT THE UNIT COMPLETELY OFF THE GROUND. LIFTING THE UNIT SO THE WHEELS ARE NOT TOUCHING GROUND WILL CREATE AN UNSTABLE AND UNSAFE CONDITION.**
-

BASIC JACK OPERATION

1. Front jacks or Landing gear jacks.
2. Level-Up jacks.

Landing gear jacks can be operated any time the system is "ON" but NOT in the "AUTO MODE." By pushing the "FRONT" button, both front or landing gear jacks can be extended. If the touch panel is put in the "RETRACT" mode, indicated by the orange illuminated LED next to the "RETRACT" button, the front jacks can be retracted together by pushing the "FRONT" button.

The Level-Up jacks operate when the "AUTO MODE" is activated or the touch panel is in the "MANUAL MODE." Once system is in "MANUAL MODE," pressing the "REAR" button will extend all Level-Up jacks at the same time. Press the "LEFT" or "RIGHT" buttons to operate Level-Up jacks to move on the left or right side of the coach, respectively.

PRIOR TO OPERATION

The leveling system shall only be operated under the following conditions:

1. The unit is parked on a reasonably level surface.
2. Be sure all persons, pets and property are clear of the coach while LCI Level-Up Automatic System is in operation.

DROPPING OFF UNIT

1. Push touch panel "ON/OFF," Fig. 2(A) to turn system on. LCD Screen lights up, Fig. 2(B).



Fig. 2 - Touch Panel

2. LCD will display status ... "NOT READY JACKS: UP"

NOTE: Orange arrow lights, Fig. 2(C) may come on, indication the current disposition of the unit, in this case the FRONT and RIGHT sides of the unit are low.

3. Push "FRONT BUTTON" to extend landing gear jacks and lift front of vehicle to take the weight of the 5th wheel off of the hitch.

IMPORTANT!

When unhooking the 5th wheel, it is imperative that the front of the coach be lifted above level. The auto level and automatically returning pinbox to drop off height functions both depend on the front of the 5th wheel to be lifted above level in order to operate properly.

4. Uncouple the fifth wheel connection on the tow vehicle.
5. Pull tow vehicle away and park at a safe distance.
6. Push "AUTO LEVEL." The unit will commence to auto level by setting the landing gear jacks close to level. The driver side rear jack will then extend and touch the ground, followed by the passenger side rear jack. There may be several level checks from the system at this time.
7. When auto level is complete, LCD indicates "READY - Jacks: Down" and the green light in the middle of the jack buttons will light Fig. 3(D).
8. Push "ON/OFF" button to turn system off or system will time out and shut off automatically.



Fig. 3 Touch Panel - Unit Level

RECONNECTING THE UNIT TO A TOW VEHICLE

1. Be sure main power switch "ON."
2. LCD display will indicate "READY: JACKS DOWN."
3. Push "LEFT" and "RIGHT" buttons at the same time.
4. Unit will raise up to the point where the AUTO LEVEL was started, (normal starting point from where it was disconnected from the tow vehicle).
5. Connect tow vehicle and make sure 5th wheel and pin are connected and locked.
6. Push "UP" arrow until "AUTO RETRACT" appears in LCD screen.
7. Push "ENTER." System will immediately retract all jacks.

MANUAL OPERATION, HYDRAULIC

1. Front jacks

NOTE: The front jacks will operate manually any time system is "ON" except "AUTO MODE."



Fig. 4



Fig. 5

- 1) Push "ON/OFF" to turn system on.
 - 2) Push "UP" ARROW once or until screen reads "MANUAL MODE."
 - 3) Push "ENTER" once while screen reads "MANUAL MODE."
 - 4) Push "FRONT" to extend front landing gear legs.
 - 5) Push "RETRACT" and orange LED, Fig. 6, comes on.
 - 6) Push "FRONT" to retract front landing gear legs:
- NOTE:** If orange LED is on legs will retract
If orange LED is off legs will extend
- 7) Push "ON/OFF" to turn system off.
 - 8) After 3 minutes system will turn off by itself.



Fig. 6

2. Level-Up jacks - EXTEND

- a. Turn "ON/OFF" button "ON."
- b. Push scroll arrow to display "MANUAL MODE," see Fig. 4
- c. Push "ENTER," see Fig. 4. "MANUAL MODE" displayed, Fig. 5

Level-Up jacks - RETRACT

- e. To retract, push "RETRACT" (orange LED lights up), see Fig. 6
- f. Push "REAR" to retract all Level-Up jacks.
- g. To extend, the "RETRACT" light should be "OFF."

NOTE: By pushing "RIGHT," both passenger side Level-Up jacks operate; pushing "LEFT," both driver's side Level-Up jacks operate and so on.

NOTE: The side to side movement in manual mode is limited to 5° of tilt.

ZERO SETTING THE CONTROL

1. Turn "ON/OFF" button "OFF"
2. Push "FRONT" button 10 times,
3. Push "REAR" button 10 times
4. Control will flash and beep, LCD says "ZERO POINT CALIBRATE"
5. To memorize this level condition, press "ENTER"
6. LCD says "ZERO POINT STABILITY SUCCESSFULLY SET"
7. The control will then turn off.
8. Turn "ON/OFF" on to commence operation.

REPLACEMENT COMPONENTS

- 195860 - LEVEL-UP JACK
- 177094 - CARTRIDGE VALVE
- 176954 - SPADE COIL
- 194712 - 4-WAY MANIFOLD
- 241314 - TOUCH PAD HARNESS
- 241318 - 9 PIN HARNESS
- 241317 - CONTROLLER TO SATELLITE HARNESS
- 234802 - TOUCH PAD
- 232201 - SATELLITE LEVEL SENSOR
- 241129 - LEVEL-UP CONTROLLER
- 142927 - PSI SWITCH
- 118246 - TROMBETTA MOTOR SOLENOID
- 138421 - RED RESTRICTED FLOW BLOCK

ERROR DISPLAY IN LCD

1. If an error occurs before or during operation, the error will be displayed in the LCD and a "buzzer " will sound
2. The errors that will be displayed are.
 - a. "EXCESS ANGLE" > relocate the unit.
 - b. "BAD CALIBRATION" > bad zero point.
 - c. "FEATURE DISABLE"
 - d. "LOW VOLTAGE"
 - e. "OUT OF STROKE" > relocate the unit.
 - f. "EXTERNAL SENSOR" > bad connection to rear remote sensor.
 - g. "JACK TIME OUT" > system could not level in expected time, check for obstructions, leaks, fluid level and voltage to pump motor under load.
 - h. "AUTO LEVEL FAILURE" > retry.
 - i. "STABILIZER TIME"> rear stabilizers ran too long ... bad motor or connections.
 - j. "NOT CONFIGURED" > unit was not zeroed properly.
 - k. To clear error, push "ENTER" > if error remains, it will appear again.

FLUID RECOMMENDATION

The *Lippert Hydra-Electric 5th Wheel Leveling System* is pre-filled, primed and ready to operate direct from the manufacturer. Please consult with the manufacturer of your unit for the fluid type in your hydraulic unit.

PREVENTATIVE MAINTENANCE PROCEDURES

1. Change fluid in **RESERVOIR ONLY** every 36 months.
 - a) Check fluid only when jacks are fully retracted.
 - b) Always fill the reservoir with the jacks in the fully **retracted** position. Filling reservoir when jacks are extended will cause reservoir to overflow into its compartment when jacks are retracted.
 - c) When checking fluid level, fluid should be within ¼" of fill spout lip.
2. Check the fluid level every month.
3. Inspect and clean all Pump Unit electrical connections every 12 months. If corrosion is evident, spray unit with WD-40 or equivalent
4. Remove dirt and road debris from jacks as needed.
5. If jacks are down for extended periods, it is recommended to spray exposed leveling jack rods with a silicone lubricant every seven days for protection. If your coach is located in a salty environment, it is recommended to spray the rods every 2 to 3 days.

WARNING:

Your coach should be supported at both front and rear axles with jack stands before working underneath. Failure to do so may result in personal injury or death.

6. If jacks are down for extended periods, it is recommended to spray exposed leveling jack rods with a silicone lubricant every seven days for protection. If your coach is located in a salty environment, it is recommended to spray the rods every 2 to 3 days.

**IF YOU HAVE ANY PROBLEMS OR QUESTIONS CONSULT YOUR LOCAL AUTHORIZED DEALER OR CALL LIPPERT AT:
(866) 524-7821.**



MANUAL OVERRIDE PROCEDURE FOR LEVEL-UP SYSTEMS

TO MANUALLY OVERRIDE LEVEL-UP SYSTEM IN THE EVENT THE PUMP UNIT IS INOPERABLE:

1. Locate all valves that operate the level-up Jacks. There will be two (2) level-up jack valves on a three (3) valve manifold. The third valve is for the landing Gear. The Level-Up Valves can be identified by the color of wires attached to the valve coils. The valve coil with the purple wire corresponds to the level-up Jacks on the driver side of the unit and the blue wire will correspond to the passenger side Level-Up Jacks. The valve coil with the grey wire corresponds to the Landing Gear.
2. To manually operate the system, the level-up valves must first be overridden. Locate the hex head set screw at the end of the valve. This is the manual override for the valve. For normal operation, this override set screw must be in the fully counterclockwise position. To override the valve, insert a 5/32" Allen wrench into the manual override and turn the override clockwise 1 1/2 to 2 turns.



Fig. 1

3. Once the valve(s) are manually overridden, the motor can now be overridden using a hand drill with a 1/4" hex head bit. Peel off protective label covering the override. Fig. 2. Run the drill clockwise to extend the level-up jacks and counterclockwise to retract. Fig 3.



Fig. 2



Fig. 3

4. Be sure to turn the manual override in the valves back to normal operation or counterclockwise when the operation is finished.

CAUTION!

Do not manually retract hydraulic landing gear jacks unless coach is supported with jack stands, a king pin stand or a tow vehicle. Retracting the landing gear without support can result in damage to the unit, property or cause serious bodily injury.



GROUND CONTROL - ELECTRIC LEVELING

WARNING!

FAILURE TO ACT IN ACCORDANCE WITH THE FOLLOWING MAY RESULT IN SERIOUS PERSONAL INJURY OR DEATH.

THE USE OF THE *GROUND CONTROL - GEN II* TO SUPPORT THE UNIT FOR ANY REASON OTHER THAN WHICH IT IS INTENDED IS PROHIBITED BY LIPPERT'S LIMITED WARRANTY. THE LIPPERT LEVELING SYSTEM IS DESIGNED AS A "LEVELING" SYSTEM ONLY AND SHOULD NOT BE USED TO PROVIDE SERVICE FOR ANY REASON UNDER THE COACH SUCH AS CHANGING TIRES OR SERVICING THE LEVELING SYSTEM.

LIPPERT COMPONENTS, INC. RECOMMENDS THAT A TRAINED PROFESSIONAL BE EMPLOYED TO CHANGE THE TIRE ON THE UNIT. ANY ATTEMPTS TO CHANGE TIRES OR PERFORM OTHER SERVICE WHILE UNIT IS SUPPORTED BY THE *GROUND CONTROL - GEN II* COULD RESULT IN DAMAGE TO THE 5TH WHEEL AND/OR CAUSE SERIOUS INJURY OR DEATH.

WARNINGS!

- > BE SURE TO PARK THE UNIT ON SOLID, LEVEL GROUND.**
 - > CLEAR ALL JACK LANDING LOCATIONS OF DEBRIS AND OBSTRUCTIONS. LOCATIONS SHOULD ALSO BE FREE OF DEPRESSIONS.**
 - > WHEN PARKING THE UNIT ON EXTREMELY SOFT SURFACES, UTILIZE LOAD DISTRIBUTION PADS UNDER EACH JACK.**
 - > PEOPLE AND PETS SHOULD BE CLEAR OF UNIT WHILE OPERATING LEVELING SYSTEM.**
 - > NEVER LIFT THE UNIT COMPLETELY OFF THE GROUND. LIFTING THE UNIT SO THE WHEELS ARE NOT TOUCHING GROUND WILL CREATE AN UNSTABLE AND UNSAFE CONDITION.**
-

BASIC JACK OPERATION

1. Front Landing gear jacks.
2. Rear leveling jacks.
3. Middle stabilizer jacks

Landing gear jacks can be operated any time the system is "ON" but NOT in the "AUTO MODE." By pushing the "FRONT" button, both front landing gear jacks can be extended. By pushing either the "LEFT" or "RIGHT" button, the individual front jacks can be extended. If the touch panel is put in the "RETRACT" mode, indicated by the orange illuminated LED next to the "RETRACT" button, the front jacks can be retracted together by pushing the "FRONT" button or individually by pressing either the "LEFT" or "RIGHT" button.

The rear jacks can only be operated when the touch panel is in the "MANUAL MODE." Once system is in "MANUAL MODE," pressing the "REAR" button will extend both rear jacks at the same time. To operate individual rear jacks, press the "LEFT" or "RIGHT" button first, depending on what is needed at the time; then press the "REAR" button and hold both at the same time.

PRIOR TO OPERATION

The leveling system should only be operated under the following conditions:

1. The unit is parked on a reasonably level surface.
2. Be sure all persons, pets and property are clear of the coach while Lippert Hydra-Electric 5th Wheel Leveling System is in operation.
3. Make sure battery(ies) are fully charged and load test is at 12+VDC.
4. Drop inner legs on all jacks. Drop tubes to their lowest position and engage spring pin.

DROPPING OFF UNIT

1. **CAUTION! Loosen J.T. Strong Arm Stabilizer "T" handles. (If applicable.)**
2. Disconnect fifth wheel latch.
3. Turn battery power "ON."



FIG. 1A Off

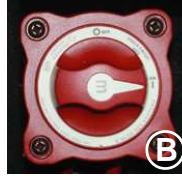

FIG. 1B ON

4. Push touch panel "ON/OFF," Fig. 2A to turn system on. LCD Screen lights up, Fig.2B.



FIG. 2 - Touch Panel

5. Push the DOWN ARROW to scroll until "DROP FRONT JACKS" is on LCD screen.
NOTE: Orange arrow lights, Fig. 2C may come on, indicating the current disposition of the unit, in this case the FRONT and RIGHT sides of the unit are low.
6. Push "ENTER." Both front landing gear jacks will go to ground and stop.
7. Push "FRONT" button to extend front landing gear jacks manually and lift front of vehicle to clear the 5th wheel hitch plate.
8. Pull tow vehicle away and park at a safe distance.
9. Push "AUTO LEVEL." The unit will commence to auto level by setting the landing gear jacks close to level. Rear-most jacks will extend to ground, followed by a second ground verification leveling jacks.
10. When auto level is complete, middle stabilizer jacks will automatically extend, stabilizing the center of the unit. LCD indicates LEVEL SUCCESSFUL.
11. Tighten the J.T Strong Arm stabilizer "T" handles if applicable.

TAKING UP STRUT PIN SLOP (If J.T Strong Arm Stabilizers are installed ONLY!)

1. After leveling is complete, LCD screen will read "LEVEL SUCCESSFUL/CHECK STABILIZERS."
2. Push "FRONT" button (**momentarily**) until front stabilizer pins are tight.
3. Push "REAR" button (**momentarily**) unit rear stabilizer pins are tight.
4. Push "ON/OFF" button to turn system off.



FIG. 3 Touch Panel - Unit Level

RECONNECTING THE UNIT TO A TOW VEHICLE

1. Be sure main power switch "ON."
2. **CAUTION! Loosen J.T. Strong Arm Stabilizer "T" handles. (If applicable.)**
3. Push Touch Pad "ON/OFF" button to turn system on.
4. Push "DOWN ARROW" to scroll to AUTO RETRACT REAR JACKS and push "ENTER."
Rear jacks will fully retract and stop.
5. Push "LEFT" & "RIGHT" button together. Front will raise to previous drop off height. Push "FRONT" button if more height is needed.
6. Back tow vehicle to align 5th wheel hitch.
7. Push "RETRACT" button. Orange LED will illuminate, Fig. 4
8. Push the scroll arrow to display "AUTO RETRACT ALL."
9. Push "ENTER." Landing Gear jacks will automatically retract and then stop.
10. Raise inner drop leg with foot and set the pin.
11. Turn "ON/OFF" button off.

TRUCK HAULER OPERATION (MANUAL ONLY)

1. **CAUTION! Loosen J.T. Strong Arm Stabilizer "T" handles. (If applicable.)**
2. Turn the Touch Panel "ON." LED lights up green.
3. Push "FRONT" button to extend FRONT jacks to gain height.
4. To retract jacks:
 - a. Push "RETRACT" button; Orange LED lights up.
 - b. Push the "FRONT" button to retract jacks and hook up vehicle. Once 5th wheel is coupled, push "FRONT" button and hold until jacks are fully retracted.
 - c. Let off "FRONT" button and push "ON/OFF" button to turn system off. Green light goes out.
 - d. Double check 5th wheel latch is secure and that all jacks are retracted.
 - e. Ready to tow.



FIG. 4



FIG. 5

ZERO SETTING THE CONTROL

NOTE: Middle stabilizers are not used in this process.

1. Turn "ON/OFF" button "OFF"
2. Push "FRONT" button 10 times,
3. Push "REAR" button 10 times
4. Control will flash and beep, LCD says "ZERO POINT CALIBRATE"
5. Manually operate the jacks to attain unit level condition (use carpenter's level).
6. To memorize this level condition, press "ENTER"
7. LCD says "ZERO POINT STABILITY SUCCESSFULLY SET"
8. The control will then turn off.
9. Turn "ON/OFF" on to commence operation.

ERROR DISPLAY IN LCD

1. If an error occurs before or during operation, the error will be displayed in the LCD and a "buzzer " will sound
2. The errors that will be displayed are.
 - a. "EXCESS ANGLE" > relocate the unit.
 - b. "BAD CALIBRATION" > bad zero point.
 - c. "FEATURE DISABLE" > Cycle Main Power or system not zero calibrated.
 - d. "LOW VOLTAGE"
 - e. "OUT OF STROKE" > relocate the unit.
 - f. "EXTERNAL SENSOR" > bad connection to rear remote sensor.
 - g. "JACK TIME OUT".
 - h. "AUTO LEVEL FAILURE" > retry.
 - i. "STABILIZER TIME"> rear stabilizers ran too long ... bad motor or connections.
 - j. "NOT CONFIGURED" > unit was not zeroed properly.
 - k. To clear error, push "ENTER" > if error remains, it will appear again.
3. Special JACK codes
 - LF JACK
 - RF JACK
 - LR JACK
 - RR JACK
- a. If any of these error codes appear, the system does have manual control over the jacks to prevent being stuck.
- b. It is important that once the error code has been resolved, the user of the unit must manually retract all jacks completely before exiting the error code. If this step is not completed, the LCD will prompt the user to complete this step as follows:
 - SAMPLE ERROR CODES
 - "ERROR"
 - "LR JACK"
 - "MANUALLY RETRACT"
 - "ALL JACKS"
 - "PRESS ENTER"

PREVENTATIVE MAINTENANCE PROCEDURES

1. Remove dirt and road debris from jacks (and stabilizer struts if equipped) as needed.
2. If jacks are down for extended periods, it is recommended to spray exposed leveling jack tubes with a spray lubricant every 3 months for protection. If your coach is located in a salty environment, it is recommended to spray the rods every month.

WARNING!

Your coach should be supported at both front and rear axles with jack stands before working underneath. Failure to do so may result in personal injury or death.



TRAILER AXLE

THIS MANUAL COVERS ELECTRIC BRAKE SYSTEMS ONLY

SPRING AXLE MODELS NOS.

- LC128 = 2800 lb. Weight Rating
- LC135 = 3500 lb. Weight Rating
- LC152 = 5200 lb. Weight Rating
- LC160 = 6000 lb. Weight Rating
- LC170 = 7000 lb. Weight Rating

SPRING DROP AXLE MODELS NOS.

- LC128-D = 2800 lb. Weight Rating
- LC135-D = 3500 lb. Weight Rating
- LC152-D = 5200 lb. Weight Rating
- LC160-D = 6000 lb. Weight Rating
- LC170-D = 7000 lb. Weight Rating

TORSION MODELS NOS.

- LC128-T = 2800 lb. Weight Rating
- LC135-T = 3500 lb. Weight Rating
- LC152-T = 5200 lb. Weight Rating
- LC160-T = 6000 lb. Weight Rating
- LC170-T = 7000 lb. Weight Rating

NOTE: Models can be de-rated per manufacturer's preference or specifications.

INTRODUCTION

Combining years of experience in the trailer frame and recreational vehicle industry with the newest and most innovative technology, Lippert Components, Inc. introduces it's newest addition, The Axle and Running Gear Division. The following publication is designed to give the customer an easy-to-understand operation and service manual to provide useful and important information. The quality of the Lippert name and the finest materials utilized in the production of the Axles and Running Gear provide you with hubs, brakes, drums and spindles that make trailering and braking the finest in the industry.

Quality comes threefold to Lippert Components, Inc.

- The finest quality materials.
- The latest technology and design.
- The quality standards maintained from materials to final assembly.

All three points provide the customer with the best product they can possibly buy and the satisfaction of knowing they can trust the equipment on which they have spent their hard earned money. Lippert Components, Inc. thanks you for purchasing our Axles and Running Gear. When you speak of Lippert Components, Inc., our quality stands beside you.

IMPORTANT! BREAK-IN PERIOD (BURNISHING) FOR ELECTRIC DRUM BRAKES

The break-in period is a typical phenomenon with drum brakes and especially electric drum brakes. Electric drum brakes will require a break-in period to achieve full performance. This break-in period applies for new axles and any time new brake shoes and/or magnets are installed as part of regular maintenance.

Lippert Components has found through extensive brake testing that the break-in period for our drum brakes can range from 20 to 50 brake applications.

Brakes can be seated in by applying approximately 8-10 volts to the trailer brakes at an initial speed of 40 mph and allowing the truck/trailer combination to slow down to 20 or 25 mph. For best results do not use truck brakes during this procedure. The trailer brakes will seat in faster by using them to stop both the truck and trailer. The easiest method is to apply the trailer brakes using the manual activation lever located on the in-cab brake controller. Care must be taken to not overheat the lining material, therefore brake applications conducted at one mile intervals will suffice. The driver should feel a noticeable difference in the brake performance during this period, sometimes in as few as 10 applications. After 50 applications, the brake lining material will be fully cured from the heat and develop close to 100% contact with the brake drum surface.

This break in period not only seats the shoe lining material but also seats in the brake electromagnets. During the break-in period, the linings will wear at a faster rate than they do after they are seated in.

NOTE: Brakes should be manually adjusted after the first 200 miles of operation and periodically thereafter, approximately 3,000 mile intervals.

HUBS/DRUMS/BEARINGS

Hub Removal

To remove the hub assembly for inspection, maintenance or service, follow the six (6) steps below:

WARNING!

Lift unit by the frame and never the axle or suspension. Do not go under the unit unless it is properly supported by jack stands. Unsupported units can fall causing serious injury or death.

1. Lift trailer and support it per manufacturer's requirements.
2. Remove the wheel.
3. Remove the grease cap by prying the edge out of the hub.
4. Pull the cotter pin from the castle nut or, if the hub is equipped with the super lube system, bend the locking tang down and remove the outer spindle nut.
5. Remove the spindle washer.
6. Pull the hub off the spindle. Do not let the outer bearing cone fall free of the assembly. The inner bearing cone will be contained by the seal and will not fall out.

NOTE: A gear puller may be necessary to remove hub from spindle.

| Drum | Diameter |
|------|----------|
| 10" | 10.090" |
| 12" | 12.090" |

Brake Drum Inspection

The brake shoes contact the drum surface and the magnet contacts the armature. These surfaces are subject to wear and should be inspected periodically. The drum surface should be remachined if scored more than .020" or out of round by more than .015". The drum should be replaced if scoring or wear is greater than .090". The inner surface of the brake drum that contacts the brake magnet is the armature surface. If the armature surface is scored or worn unevenly, it should not be machined any more than .030". The magnets should be replaced whenever the armature surface is refaced and vice versa.

NOTE: Make certain the wheel bearing cavities are clean and free of contamination before reinstalling bearing and seals. Resurfacing procedures can produce metal chips and dust that can contaminate the wheel bearings and cause failure.

Bearing Inspection

Wash all grease and oil from the bearing cone using a suitable solvent. Dry the bearing with a clean, lint-free cloth and inspect each roller completely. If any pitting, spalling, or corrosion is present, then the bearing must be replaced. The bearing cup inside the hub must be inspected.

NOTE: Bearings must always be replaced in sets of one cone and one cup.

WARNING!

Always wear eye protection when servicing the axle, brakes, hubs, springs and wheels.
Failure to wear eye protection may result in serious injury.

Bearing Lubrication - Grease

Bearing grease should be replaced every 12,000 miles or 12 months, whichever comes first. Remove all old grease from wheel hub and bearings first. Bearings should be packed by machine if possible. Packing bearings by machine is preferable; however, packing by hand is a viable alternative.

Follow these procedures to repack bearings by hand:

1. Place grease into the palm of your hand.
2. Press widest end of bearing into the outer edge of the grease, forcing grease into the inner area of the bearing between the two adjacent rollers.
3. Repeat this process while turning bearing from roller to roller until all rollers are coated.
4. Apply a light coat of grease into the bearing cup surface.
5. Reassemble bearing into cup.

RECOMMENDED WHEEL BEARING LUBRICATION SPECIFICATIONS

Grease:

| | |
|--------------------------|--|
| Thickener Type | Lithium Complex |
| Dropping Point | 230°C (446°F) Minimum |
| Consistency | .NLGI No. 2 |
| Additives | EP, Corrosion & Oxidation Inhibitors |
| Base Oil | Solvent Refined Petroleum Oil |
| Base Oil Viscosity | @40°C (104°F) 150cSt (695 SUS) Minimum |
| Viscosity Index | .80 Minimum |
| Pour Point | -10°C (14°F) Minimum |

Approved Sources:

| | |
|---------------------------|-----------------------------------|
| Mobil Oil | Mobilgrease HP |
| Exxon/Standard | Ronex MP |
| Kendall Refining Co. | Kendall L-427 |
| Ashland Oil Co. | Valvoline Val-plex EP Grease |
| Pennzoil Prod. Co. | Premium Wheel Bearing Grease 707L |

Seal Inspection and Replacement

Always check the seal to make sure that it is not damaged, nicked, cracked or torn and is in good working order. If there is any question of condition, replace the seal. Use only the seals specified in the Seal Replacement Chart in the Trailer Axle Manual found on the LCI website - www.lci1.com

Procedure to replace seal:

1. Pull seal from the hub with a seal puller. Never push the seal out with the bearing. The bearing may get damaged.
2. Apply a PERMATEX sealant to the outside of the new seal.
3. Tap the new seal into place using a clean, hard wood block.

Bearing Adjustment/Hub Replacement

For adjusting bearings or replacement of removed hub, follow procedures below:

1. Place hub, bearing, washers and castle nut back on axle spindle in the reverse order from which they were removed. Castle nut should be torqued to 50 ft.-lb. Hub will rotate during this process.
2. Loosen castle nut to back off the torque.
3. Tighten castle nut finger tight until snug.
4. Insert cotter pin (or locking tang if equipped with Super Lube). If cotter pin or tang does not line up with hole, back castle nut up slightly until pin or tang can be inserted.
5. Bend cotter pin over to lock nut in place (or locking tang in the case of Super Lube). Nut should be free to move with only the cotter pin keeping it in place.

ELECTRIC BRAKES

THIS MANUAL COVERS ELECTRIC BRAKE SYSTEMS ONLY

The basic structure of the Electric Brakes on your trailer will resemble the brakes on your car or tow vehicle, with one major difference; your trailer implements an electric actuation system and your tow vehicle utilizes a hydraulic system. The Electric Braking System operates in the following order of steps; refer to the Electric Braking System diagram and the brake diagram to follow along:

1. Electric current is supplied to the trailer's braking system when the tow vehicle's brakes are applied.
2. From the tow vehicle's battery, the electricity flows to the brake's electromagnet.
3. When energized the electromagnets are attracted to the rotating surface of the drums.
4. This moves the actuating levers in the direction the drums are turning.
5. The actuating cam at the end of the shoe forces the primary shoe out to the drum surface.
6. The force of the primary shoe actuates the secondary shoe to contact the drum.
7. The force applied to the brake drum can be increased by elevating the current flow to the electromagnet.
8. Brake nuts to secure the backing plate to the flange should be torqued at 30-50 lbs.

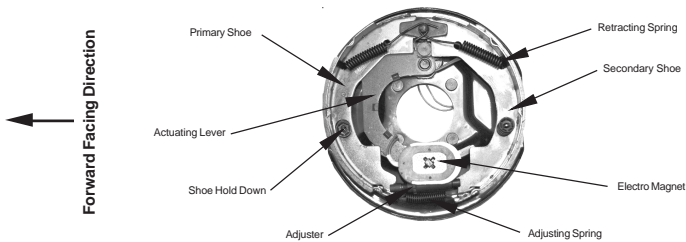

How to Use Your Electric Brakes Properly

The Lippert Components, Inc. Electric Braking System is synchronized with your tow vehicle brakes.

WARNING!

Never attempt to stop the combined load of the tow vehicle and the trailer by using either the tow vehicle brakes or the trailer brakes only. They are designed to work together.

You may have to manually make small adjustments occasionally to accommodate changing loads and driving conditions. Synchronization of tow vehicle to trailer braking can only be accomplished by road testing. Locking up, excessive grab, or delayed application is quite often due to the lack of synchronization between the tow vehicle and the trailer being towed. High voltage (2V+), low voltage (2V-) or improperly adjusted brakes are the most common cause of these problems and can be easily remedied. Prior to any adjustments, your trailer brakes should be burnished-in by applying the brakes 20-30 times with a 20 m.p.h. decrease in speed, e.g. 40 m.p.h. to 20 m.p.h. Allow ample time for brakes to cool between application. This allows the brake shoes and magnets to begin seating to the brake drum.

TRAILER WIRE GAUGE CHART

| Gauge and Type of Wire | Number of Axles | Length of Run |
|-------------------------------|------------------------|----------------------|
| 16 gauge stranded copper | 1 | N/A |

STORAGE

Storage Preparation

If your trailer is to be stored for an extended period of time the trailer will need to be prepared prior to going into storage. Follow these guidelines to setup your trailer for storage:

1. If the trailer has an emergency breakaway battery remove it and store it inside, out of the weather. Charge the battery at least every 90 days.
2. Jack up the trailer and place jack stands under the trailer frame so that the weight will be off the tires. Follow trailer manufacturer's guidelines to lift and support the trailer.
3. Lubricate mechanical moving parts such as the hitch, and suspension parts, that are exposed to the weather.
4. In the case of boat trailer axles that are subject to repeated immersion, remove brake drums; clean, dry and re-lubricate moving brake components; inspect bearings - clean and re-lubricate. **Extended Storage Inspection Procedures**

Procedures

Trailer should remain on jack stands during this procedure:

1. Remove all wheels and hubs or brake drums. Reinstall drum to same spindle and brake from where it was removed.
2. Inspect suspension for wear.
3. Check tightness of hanger bolt, shackle bolt, and U-Bolt nuts of the suspension for correct torque.
4. Check brake linings, brake drums and armature faces for excessive wear, scoring, damage or corrosion.
5. Check brake magnets with an ohmmeter. The magnets should check 3.2 ohms. If shorted or worn excessively, they must be replaced.
6. Lubricate all brake moving parts using a high temperature brake lubricant.
7. Remove any rust from braking surface and armature surface of drums with fine emery paper or crocus cloth. Be sure to protect bearings from contaminating dust.
8. Inspect oil or grease seals for wear or nicks. Replace if necessary.
9. Lubricate hub bearings.
10. Reinstall hubs and adjust bearings.
11. Mount and tighten wheels.

Trip Preparation Checklist

The following checklist offers several guidelines to prolonging the quality of your running gear and will provide trustworthy and safe trailering for years to come. Using the following checklist before starting a trip with your trailer is highly recommended. Allow plenty of time prior to any trip for any service or repairs that may need to be done before using the trailer.

1. Maintenance schedule should be current.
2. Inspect hitch for corrosion, lubrication and wear.
3. Inspect safety chains for rust and wear. Engage chains and breakaway switch actuating chains securely. Breakaway battery should be fully charged.
4. Electronic coupler must be secure. Run check on all lights and break engagement and synchronization.
5. Load trailer with 10% of total weight on the hitch end of trailer. Smaller trailers front end load should be increased to 15%.
6. **DO NOT OVERLOAD!** Consult your trailers i.d. plate for gross vehicle weight restrictions.
7. Tires should be inflated to manufacturer's specifications. Inspect tires for any damage or wear.
8. Inspect lug nuts/bolts. All should be torqued to specification.
9. Check torque of hanger bolt, shackle bolt, and U-Bolt nuts on suspension.
10. Check that your trailer is towing level. Adjust hitch height if necessary to level trailer.

WARNING!

Lift unit by the frame and never the axle or suspension. Do not go under unit unless it is properly supported by jack stands. Unsupported units can fall causing serious injury or death.
Avoid getting any grease or oil on brake linings and pads or magnet surfaces.

MAINTENANCE SCHEDULE

| Item | Function Required | Weekly | 3 Months/ 3,000 Mi | 6 Months/ 6,000 Mi | 12 Months/ 12,000 Mi |
|----------------------|---|--------|-----------------------|-----------------------|-------------------------|
| Brakes | Test that they are operational | | | | At Every Use |
| Breakaway System | Check battery charge and switch operation | | | | At Every Use |
| Brake Adjustment | Adjust to proper operating clearance | | ★ | | |
| Brake Magnets | Inspect for wear and current draw | | | ★ | |
| Brake Linings | Inspect for wear and contamination | | | | ★ |
| Brake Controller | Check for correct amperage & modulation | | | ★ | |
| Trailer Brake Wiring | Inspect for bare spots, frays, etc. | | | | ★ |
| Hub/Drum | Inspect for abnormal wear or scoring | | | | ★ |
| Wheel Bearing & Cups | Inspect for corrosion or wear; clean and repack | | | | ★ |
| Seals | Inspect for leakage. Replace if removed | | | | ★ |
| Springs | Inspect for wear, loss of arch | | | | ★ |
| Suspension Parts | Inspect for bending, loose fasteners, wear | | | ★ | |
| Hangers | Inspect welds | | | | ★ |
| Wheel Nuts and Bolts | Tighten to specified torque values | | ★ | | |
| Wheels | Inspect for cracks, dents or distortion | | | ★ | |
| Tire Inflation | Inflate tires to manufacturer's specifications | ★ | | | |
| Tire Condition | Inspect for cuts, wear, bulging, etc. | | ★ | | |

GENERAL MAINTENANCE - ELECTRIC BRAKES

Brake Adjustment

WARNING!

Prior to testing or adjusting brakes, be sure area is clear of any pedestrians and vehicles.
Failure to perform test in a clear area may result in serious injury or death.

Lippert Components, Inc. Electric Brakes are manually adjustable only. If manual adjusting is needed, the following 6-step procedure can be utilized. Initially, brakes should be adjusted after the first 200 miles of operation when the brake shoes and drums have "seated." Next, check and adjust brakes at 3,000 mile intervals or sooner if they are not performing as intended. The brakes should be adjusted in the following manner:

1. Jack up trailer and secure on adequate capacity jack stands. Follow the trailer manufacturer's recommendations for lifting and supporting the unit. Make sure the wheel and drum rotates freely.

WARNING!

Lift unit by the frame and never the axle or suspension. Do not go under unit unless it is properly supported by jack stands. Unsupported units can fall causing serious injury or death.

2. Remove the adjusting hole cover from the adjusting slot on the bottom of the brake backing plate.

3. With a screwdriver or standard adjusting tool, rotate the starwheel of the adjuster assembly to expand the brake shoes. Adjust the brake shoes out until the pressure of the linings against the drum makes the wheel very difficult to turn.

4. Then rotate the starwheel in the opposite direction until the wheel turns freely with a slight lining drag.

5. Replace the adjusting hole cover and lower the wheel to the ground.

6. Repeat the above procedure on all brakes. For best results, the brakes should all be set at the same clearance.

Clean and Inspect Brakes

In the event the braking system encounters symptoms of improper application or failure, immediate inspection and service must be implemented. During normal use, servicing the braking system once a year is considered normal. Increased usage will require service on a regulated schedule based on 3,000-6,000 mile increments. As magnets and shoes become worn, they need to be changed to maintain maximum braking capability. Be sure, when disassembling brakes for cleaning, to clean the backing plate, magnet arm, magnet and shoes. Also, make sure that any and all parts removed for cleaning are placed back into the same brake drum assembly. This is also an excellent time to check for parts that have become loose or worn.

WARNING!

POTENTIAL ASBESTOS DUST HAZARD!

Older brake linings have the potential to contain asbestos dust, which has been linked to serious or fatal illnesses. Certain precautions need to be taken when servicing brakes:

1. Avoid creating and/or breathing any brake dust.

2. Do not machine, file or grind the brake linings.

3. Remove with a damp brush or cloth. Dry brushing or compressed air will cause dust particles to be airborne.

Lubricate Brakes

Prior to reassembling the brake drum assembly, remember to apply a light film of white grease or an anti-seize compound on the brake anchor pin, the actuating arm bushing and pin, and the areas on the backing plate that are in contact with the brake shoes and magnet lever arm. In addition apply a light film of grease on the actuating block mounted on the actuating arm.

Magnets

This electric braking system utilizes an electromagnet to actuate the brake shoes. These high-quality magnets provide superior force and friction to safely and effectively stop the trailer. These magnets should be inspected and serviced on the same schedule as the rest of the axle system, at least once a year for normal use and more often if the trailer is used extensively. Abnormal or uneven wear is a sign that the magnet needs to be replaced. Check the surface of the magnet with a straight edge to check for uneven wear. The surface of the magnet should be completely flat. If the magnet's coil is exposed in any way, even if normal wear is evident, the magnets should be replaced immediately. If the electromagnets are replaced, the drum armature surface should also be replaced. If a magnet is replaced on one side of an axle, it is recommended that the magnet on the opposite brake assembly also be replaced to ensure even braking capacity.

Shoes and Linings

Linings should be replaced if the material is worn to 1/16" or less. Shoes should also be replaced if they become contaminated with grease or oil or have become scored, pitted or gouged. Heat cracks are normal and rarely require attention. When replacing shoes, both shoes on the same brake and the brakes on the same axle should all be replaced at the same time, once again ensuring even braking capacity. Brake linings should be replaced with the similar lining material or obtained directly from LCI. Brake lining data can be found on the surface of the brake lining. This information can be used to find correct replacement brake lining material. After replacing shoes and linings, your trailer brakes should be burnished-in by applying the brakes 20-30 times with a 20 m.p.h. decrease in speed, e.g. 40 m.p.h. to 20 m.p.h. Allow ample time for brakes to cool between application. This allows the brake shoes and magnets to begin seating to the brake drum.

Axle & Suspension Installation

The single most important portion of axle installation is parallel alignment of the trailer axle(s) to the tow vehicle or drive axle(s). Parallel installation allows for correct and safe control, prolonged tread life and will all but eliminate dog-tracking. Proper alignment is most readily achieved by measuring from the center of the trailer king pin to the center of each end of the axles. The tolerance should not vary any more than 1/16". The difference between the centers of one axle and end centers of the other axle must not vary more than 1/8" in multiple axle configurations. Lippert Components, Inc. tubular axles are made of high strength steel to prevent metal fatigue and provide the best possible welding conditions. The round tubular axles allow for even and uniform structure.

Directions:

1. Position brake axles (if used) so that lead wires are on the roadside of the trailer.
2. For leaf spring axles, use all AP kits provided with axle to install as shown in Fig.1 below and torque fasteners as specified in the chart below.

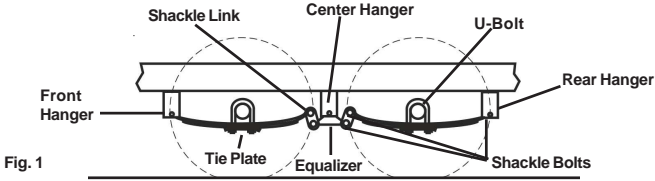

Fig. 1

Spring Axle Torque Specifications

| Axle Size | Minimum ft.-lb. | Maximum ft.-lb. |
|---------------|-----------------|-----------------|
| U-Bolts | 55 | 70 |
| Shackle Bolts | 30 | 50 |

3. For Torsion installation, mount axle bracket to frame bracket (shown in Fig. 2 below) and torque fasteners as specified in the chart below.

Torsion Torque Specifications

| Axle Size | Bolt Size | Torque ft.-lb. |
|-----------|-----------|----------------|
| #8-#9 | 1/2 | 70-90 |
| #10-#13 | 5/8 | 120-155 |

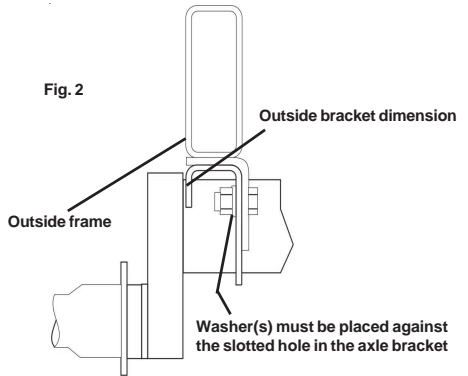

Fig. 2

NOTE: Low profile brackets have plain round holes

WARNING!

Always wear eye protection when servicing the axle, brakes, hubs, springs and wheels. Failure to wear eye protection may result in serious injury.

Suspension Systems

The suspension systems incorporated into Lippert Components, Inc. axles are designed to provide the following benefits:

1. Attach the axle to the trailer.
2. Dampen the effects of road shock.
3. Provide stability to the trailer.

All Lippert suspension systems are available in single and multiple axle configurations. For specific or custom applications, please contact Lippert Components, Inc. Axle Division.

Double-Eye Leaf Springs

Double-eye leaf springs have eyes at either end of the spring assembly with nylon bushings to assist in preventing wear. U-Bolts hold the springs to the axle with a plate. The articulation of this suspension occurs when the eyes rotate on the wear surfaces provided in eyes of the springs and on the equalizers. This suspension is also available in single and multiple axle configurations. In trailers with two (2) or more axles, the additional movement is maintained by an equalizer. This feature allows for even load handling from axle to axle.

Torsion Suspension System

1. The Lippert Components, Inc. Torsion Suspension system is designed to offer superior qualities over leaf spring technology. The Lippert Components, Inc. Torsion Suspension system is bracketed to the trailer's frame and housed inside the trailer axle's tube.
2. The spindle is connected to a swing arm, the swing arm is connected to a square inner bar that is sheathed in rubber and as the swing arm rotates and experiences the torque and resistance of driving conditions, the characteristics of the rubber absorb and distribute the load providing benefit over leaf springsuspensions.
3. The Lippert Components, Inc. Torsion Suspension system requires very little attention in regards to maintenance. Normal inspection of the entire Lippert Components, Inc. Trailer Axle system can be applied to the Torsion Suspension system. See inspection procedures for system components in this manual.

Inspection

All the components of your suspension system should be visually inspected for signs of wear, damage or loose fasteners at least every 6,000 miles. When replacing or tightening loose fasteners, consult the torque charts on pages 28 for correct torque values. Worn spring eye bushings or sagging or broken springs should be replaced using the following method:

1. Support the trailer with the wheels just off the ground. Follow the manufacturer's recommendations for lifting and supporting the unit.
2. After the unit is properly supported, place a suitable block under the axle tube near the end to be repaired. This block is to support the weight of the axle only so that SUSPENSION COMPONENTS can be serviced or replaced.
3. Disassemble the U-Bolts, nuts, and tie plates.
4. Remove the spring eye bolts and the spring.
5. If the spring eye bushings are to be replaced, press out the old bushing by hand or tapping out with a punch.
6. Free-floating nylon bushing needs no lubrication. Press the new bushing into the spring eye by hand or gently tapping it in with a bounceless rubber or plastic mallet.
7. Reinstall repaired or replaced components in reverse order.

NOTE: For multiple axle units, the weight of each axle must be supported as outlined in step 2 before disassembly of any component of the suspension system.

WARNING!

Lift unit by frame and never by axle or suspension. Do not go under unit unless it is properly supported by jack stands. Unsupported units can fall causing serious injury or death. Always wear eye protection when servicing the axle, brakes, hubs, springs and wheels. Failure to wear eye protection may result in serious injury.

If the equalizer or equalizer bushings must be replaced, follow the instructions above for lifting and supporting the trailer unit and then proceed as follows:

1. With both axles blocked up, remove the spring eyebolt, keeper bolt, and equalizer bolt from the equalizer to be repaired or replaced.
2. Press the old nylon bushing out of the equalizer.
3. Reassemble in reverse order.

Suspension Replacement

1. Make sure springs are on straight. Align spring eyes to front hanger. Insert spring eye bolts but do not torque at this point.
2. Assemble springs into equalizer.
3. After leveling equalizer to frame, torque equalizer nuts and spring eye nuts to a minimum of 45 ft.-lb. and a maximum of 70 ft.-lb.

Fastening Multiple Leaf Springs to RV Axle Beams and Frame

1. Locate spring such that the spring clip is towards the front of the axle.
2. Locate spring center bolt in the center hole of spring pad.
3. Attach spring using NEW U-Bolts, nuts and tie plates. Torque nuts to a minimum of 45 ft.-lb. and a maximum of 70 ft.-lb.
4. Attach axle and spring assembly with spring eye bolt. Torque nuts on shoulder type spring eye bolts between 30 to 50 ft.-lb. Tighten 9/16" spring eye bolt locknuts to "snug fit only" showing one (1) or two (2) threads out of the top of the lock nut.

WHEELS

Wheel Selection

When specifying or replacing your trailer wheels it is important that the wheels, tires, and axle are properly matched. The following characteristics are extremely important and should be thoroughly checked when replacement wheels are considered:

- 1. Bolt Circle.** Wheels have many bolt circle variations and some are so close that it could be possible to attach an inappropriate wheel that does not match the axle hub.
- 2. Capacity.** Wheel load capacity should match tire and trailer maximum load ratings.
- 3. Offset.** The relationship of the center line of the tire to the hub face of the axle should match any replacement. Failure to match offset may result in reducing the carrying capacity of your axle.
- 4. Rim Contour.** Replacement wheels should be direct replacements to match the rim contour.

Inspection

All of the components of your suspension system should be visually inspected for signs of wear, damage or loose fasteners at least every 6,000 miles. When replacing or tightening loose fasteners, consult the torque chart for correct torque values. Worn spring eye bushings or sagging or broken springs should be replaced.

WARNING!

Use only rim contours suggested by manufacturer. Failure to use correct rim contour may cause dramatic separation of tire and wheel and could cause serious injury or death.

Attempting to modify or repair a wheel can cause unsafe conditions that may result in an explosion. Air pressure on a weakened or cracked rim can cause serious injury or death.

Torque Requirements

It is extremely important to apply and maintain proper wheel mounting torque on your trailer axle. Torque wrenches assure the proper amount of torque is being applied to a fastener. Use no other method to torque fasteners.

WARNING!

Proper and accurate torque must be maintained to prevent wheels from loosening, studs from cracking and/or breaking or other possible hazardous breakage resulting in serious injury or death.

Be sure to use only the fasteners matched to the cone angle of your wheel, (usually 60° or 90°). The proper procedure for attaching your wheels is as follows:

1. Start all bolts or nuts by hand to prevent cross threading.
2. Tighten bolts or nuts in the following sequence.
3. Tightening fasteners should be done in stages. Follow the recommended sequence, tighten fasteners per wheel torque requirements diagram (see below).
4. Wheel nuts/bolts should be torqued before first road use and after each wheel removal. Check and re-torque after the first 50 miles and again at 100 miles. A periodic check during regular service is recommended.

| Wheel Sizes | Torque Sequence | | |
|---------------------------------|-----------------|-------------------------------|-----------|
| | 1st Stage | 2nd Stage | 3rd Stage |
| 14" - 15" - 16" - 16.5" x 6.75" | 1/2" | 20-25 | 50-60 |
| 16" - 16.5" x 6.75" | 9/16" | 20-25 | 60-70 |
| 17.5" w/long nut | 5/8" | 50-60 | 100-120 |
| 17.5" w/flange nut | 5/8" | 50-60 | 150-200 |
| 14.5" Demount | 1/2" | tighten sequentially to 85-95 | |

NOTE: All torque in ft.-lb.

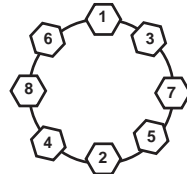
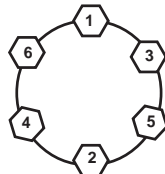
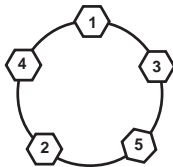







LUG TIGHTENING SEQUENCE CHART

TIRES

Prior to mounting tires onto wheels, be sure the rim size and contour are approved by the Tire and Rim Association Yearbook or the Tire Manufacturers Catalog in the United States and Recreational Vehicle Running Gear Certification - CSA CAN3 D313 in Canada. Use only tires, rims and wheels complying with CMVTSS 109 and CVMTSS110; or CMBTSS 119 and CMVTSS 120. In addition, confirm that the tire will carry the rated load. If the load is not evenly distributed on all tires, use the tire rated for the heaviest wheel position. The Rubber Manufacturers Association or the tire manufacturers guidelines should be consulted for mounting procedures. Tire inflation pressure is the most important factor in tire life. Tire pressure should always be what is recommended by the manufacturer for the load. Always check tire pressure before operation. **DO NOT** bleed air from tires when they are hot. Check inflation pressure weekly during use to insure maximum tire and tread life. The following tire wear diagnostic chart will help you pinpoint the causes and solutions of tire wear problems.

NOTE: Tire wear should be checked frequently because once a wear pattern becomes firmly established in a tire it is difficult to stop, even if the underlying cause is corrected.

| | | PROBABLE CAUSE | CORRECTIVE ACTION |
|-------------|---|-------------------------------|---|
| CENTER WEAR |  | Over-inflation | Adjust pressure to particular load per tire catalog. |
| EDGE WEAR |  | Under-inflation | Adjust pressure to particular load per tire catalog. |
| SIDE WEAR |  | Loss of camber or overloading | Make sure load doesn't exceed axle rating. Align at alignment shop or service center. |
| TOE WEAR |  | Incorrect toe-in | Align at alignment shop or service center. |
| CUPPING |  | Out-of-balance | Check bearing adjustment and balance tires. |
| FLAT SPOTS |  | Wheel lockup & tire skidding | Avoid sudden stops if possible and adjust brakes. |



LCI CHASSIS INFORMATION

LIPPERT CHASSIS MAINTENANCE

The Lippert Chassis needs relatively little maintenance. The chassis and its components are powder coated to resist rust and corrosive materials that cause rust.

A few simple guidelines should be kept in mind to maintain the integrity of the chassis structure.

1. Never overload the trailer. The chassis is built to the specifications for GVWR (Gross Vehicle Weight Rating) set forth by the manufacturer of the trailer. Overloading the trailer may cause damage to the structure of the chassis causing residual damage to the trailer.
2. In the event the trailer is pulled through winter conditions where salt on the road can be splashed up and onto the chassis or the trailer is pulled or located near coastal areas of the country, periodically rinsing down the chassis will wash away the corrosive salt and keep the powder coat clean.
3. Pinbox mounting bolts should be torqued 90 - 110 ft. lb. and checked annually.
4. Inspect welds of cross-members, outriggers bumpers and draw bars (A-frame with coupler on the front of a travel trailer).

ISSUES RESULTING FROM IMPROPER MAINTENANCE OF CHASSIS SURFACE COATING

1. Cracks or "spider-webbing" in the powder coated surfaces.
2. Paint or powder coat flaking in large sheets.
3. Surface rust coming through powder coating.
4. Large areas of bubbling rust.

MAIN RAIL CAMBER

1. Camber is manufactured into the unit to offset the weight of the coach rear of the axles.
2. Loss of camber in the main rails, due to overload, i.e. excessive rear end weight, pulling a trailer behind the unit, may manifest in slide-outs, entry doors or interior cabinets not operating or functioning properly on one or both sides of the trailer.
3. Outriggers bent downward. Outriggers extend perpendicular off the main rails of the chassis to provide an area to fasten the house portion of the trailer to the chassis. Bending outriggers will cause slideouts, entry doors or interior cabinets to malfunction in specific areas.

AXLE HANGERS

1. Axle hangers are welded to the underside of the main rails and are brackets used to mount the axle suspension. Axle hangers should be perpendicular to the ground and parallel to the length of the main rails. Bent or damaged hangers may cause tire wear or spring issues.

RECOMMENDATIONS FOR JACKING THE FRAME TO CHANGE A TIRE

1. Carrying a jack rated for the weight of the coach is essential. The jack must be rated between 8 and 12 tons.
2. To prevent damage to the coach, carry wood blocks to place between the jack and the main rail (I-beam or tube) of the coach and to go under the jack.
3. DO NOT jack the coach on the axle tube or black pipe gas lines that can sometimes be mounted to the bottom of the main rail.
4. Chock the wheels, both front and rear, on the opposite side of the coach.
5. If hitched to tow vehicle, stay hitched and set the parking brake.
6. DO NOT use the front landing gear or rear stabilizer jacks to pick the coach up to change a tire. This is dangerous and may result in serious bodily injury or death.
7. Other options include adding Level-Up 6-point leveling, Ground Control 4 or 6-point leveling to not only assist in jacking the coach frame but to add value to the coach.



ENTRY DOOR LATCH - FASTEC, INC.

MANUAL ENTRY

Fastec door latches are installed on about 98% of all entry doors in the RV industry. They are the only manual latch used by Lippert Components, Inc.

LCI Fastec door latch comes in 3 colors; Black-50% usage; White - 40% usage; Chrome - 10%.

There are 25 different keys used for the manual door latches.

The Fastec Key code is stamped into the key as a 5 character code, e.g. HF 345, see Fig. 1.

Standard key will have a square, black plastic coating on the key handle and will have "FIC" molded on the face.

In the event of a lost key, the key code can be found on a sticker affixed to the back plate of the latch, see Fig. 2a.

Fastec's toll free number will also be listed - (800)837-2505.

KEY
CODE



Fig. 1



Fig. 2

Remove the four mounting screws found on the inside door latch. Remove inside latch to reveal key code sticker, see Fig. 2b.

A Master Key will have the same characteristics only in red plastic. The Master Key will only open the door lock and not the deadbolt.



ENTRY DOOR LATCH - SOUTHCO

KEYLESS ENTRY

Southco, Inc. door latches are used in Lippert's Keyless Entry Door systems.

All Southco units are black and the door handle is slightly curved, as opposed to the straight door handle on the Fastec.

Keypad, see Fig. 1. Keyfob, see Fig. 2.



Fig. 1



Fig. 2

The Southco key code is a 3-digit code stamped onto the key, see Fig. 3. The key handle has black molded plastic on the key handle and is rounded at the end. The Master Key bears no keycode.



KEY
CODE

Fig. 3

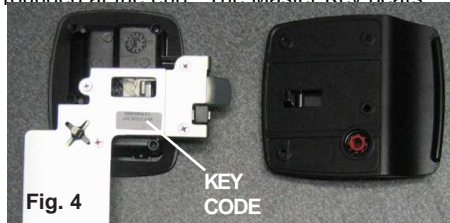

Fig. 4

KEY
CODE

If the key or key fob is lost, the keycode can be found on the latch plate, see Fig. 4, by removing the 4 screws on the inside latch handle.

Southco can be contacted directly for key - 610-459-4000.



Fig. 5



Fig. 6



Fig. 7

The receiver is mounted just below the entry door window.

The keypad and the keyfob are all matched directly to the receiver. A small black sticker with the code number is affixed directly to each component. On the keypad, the sticker is located under the 9 - 0 button, see Fig. 5. On the keyfob, in the middle of the backside of the fob, see Fig. 6. The matching code will be located on the receiver next to the antenna, see Fig. 7.

The default entry code is 1-2-3-4.



GENERAL MAINTENANCE

Couplers - Travel Trailer - Grease should be applied to inside of coupler or on hitch ball to prevent scratching and scarring and for smooth operation in travel.

Pinboxes - 5th Wheel - ALL - Rinse after winter, coastal or salt air travel. Grease on King Pin & Hitch. 110 ft./lb. torque on mounting bolts. Tri-Glide-See above pinbox maintenance. Also, grease 9 points, 3 per side, 3 on underside. See LIP Sheet 0170.

Chassis - Trailer Frame and all attaching components including Front and Rear Electric Stabilizer Jacks, Scissor Jacks, Under Chassis Storage Units, Tire Winches, Sliding and Bumper Mount Bike Racks. Wash down after winter travel on salted or otherwise treated roads or during extended period of time near coastal or salt air destinations. See LIP Sheet 0166.

Axles - Bearings - Service and Repack every 12 months or 12,000 miles. See Lippert Trailer Axle Manual for procedure and grease specs. See also LIP Sheet 0132.

Brakes - Brake Inspection & Maintenance - see LIP Sheet 0133. Any new brake assembly must go through the Break-In Period (Burnishing) to set initial contact. See LIP Sheet 0139.

Connecting Components - *Equa-Flex* - Grease every 5,000 - 8,000 miles. *Center Point* - Check for proper inflation indicated by arms positioned vertically. *Wet Bolts* - Grease every 5,000 - 8,000 miles.

Kinro - Windows - Inspect glazing around window to be free of damage, cracks or holes and that glazing goes completely around the window. Replace if damaged.

Cargo Doors - Inspect seals for damage, cracks or holes. Replace if damaged.

Ramp Doors - Inspect seals for damage, cracking or holes.

Slides - Inspect for dirt.

Inner Arms - Extend and wipe down and apply dry lube only.

Hydraulic Cylinder - Extend and wipe down piston rod and apply dry lube. Inspect hoses and hose fittings at cylinder for leaks.

Electric Actuator - Extend and wipe down inner actuator and apply dry lube. Do not leave extended for long periods of time. If unit is near coastal areas or exposed to salt air, maintain above components at least once a month.

Electric Landing Gear - Extend jacks and wipe down inner and outer jacks and apply dry lube to inner. Inspect bevel gears in top of jack to be free of dirt and contamination.

Hydraulic Landing Gear - Level-Up Jacks - Rear Hydraulic Stab Jacks - Wipe down inner and outer. Rinse outer after winter travel or coastal or salt air travel. Extend and apply dry lube to inner and piston rod where applicable. Inspect hoses and hose fittings for leaks.

Hydraulic Pump Units - Inspect for leaks around ports, hoses and fittings. Be sure fluid in reservoir is full to within 1/4" of the top.

Touch Audio - TV Lift - Door Alarm - Wireless Remote Systems - Keyless Entry -
Door and Slam Latches - Entry Doors - Manual Steps - Coachsteps

No maintenance required.

***LIPPERT CONTACT INFORMATION***

***CUSTOMER SERVICE - PLANT #39
1701 CENTURY DR..
GOSHEN, IN 46528
PH: (866) 524-7821
FAX: (574) 534-7161
E-MAIL: WARRANTY@LCI1.COM
WEBSITE: WWW.LCI1.COM***

Lippert Components must be notified of all issues prior to work being performed. For the quickest and most efficient response, Lippert Customer Service can be reached via e-mail at warranty@lci1.com. Submissions should include full unit info including last 8 of VIN#, model, Date of Mfr, Date of Purchase and Retail Owner name, or by filling out the Repair Request Form. The Repair Request Form and other service forms can be found online in addition to all owners manuals and informational publications, see specific web addresses below.

***ONLINE MANUALS, TECHNICAL INFORMATION
AND SERVICE MANUALS*****Manuals**

http://www.lci1.com/index.php?option=com_content&view=article&id=54&Itemid=66

Technical(LIP Sheets)

http://www.lci1.com/index.php?option=com_content&view=article&id=61&Itemid=68

Service Forms

http://www.lci1.com/index.php?option=com_content&view=article&id=60&Itemid=67



rev010612