

Berkshire XL



FREIGHTLINER® XCR CHASSIS WITH TRU-BRACE FOUNDATION

- + Cummins ISL Turbo Diesel 8.9 Liter 380 HP, 1150 FT/LBS of Torque
- + Allison 3000MH 6-Speed Transmission
- + Trailer Hitch with 15,000 Lbs. Capacity
- + V-Ride Rear Suspension 
- + 100 Gallon, Locking, Dual Fill Fuel Tank
- + Drivers Side Mounted 13 Gallon DEF
- + TPMS-Tire Pressure Monitoring System



BERKSHIRE XL FEATURES

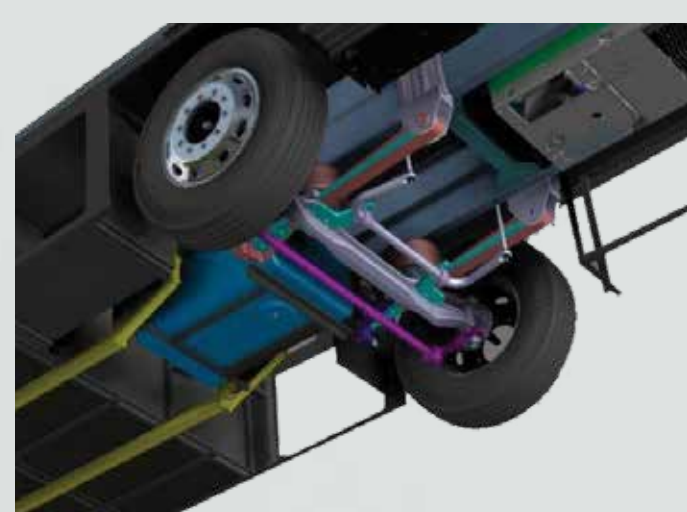

TRU-BRACE
ANTI-CAMBER SUPPORT BRACING



3 1/8" THICK FLOOR
INCREASES RIDE QUALITY, REDUCE ROAD NOISE, ADDED RIGIDITY TO THE FOUNDATION

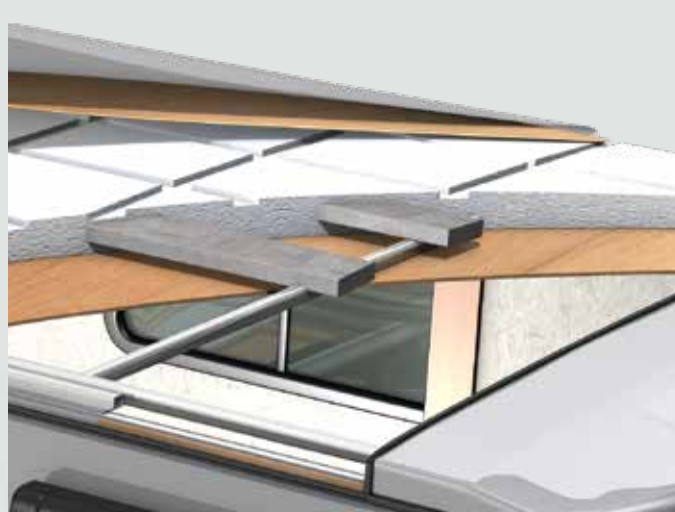

5 1/4" THICK ROOF
CROWNED ONE PIECE FIBERGLASS ROOF



NOBLE SELECT
PREMIUM COMPOSITE, HIGH GLOSS SIDEWALLS. IMPERVIOUS TO WATER, RESISTANT TO THE ELEMENTS & IMPACT, PUNCTURE RESISTANT



HOUSE BATTERIES
(6) SIX VOLT DEEP CYCLE HOUSE BATTERIES



2800 WATT INVERTER
2800W PURE SINE WAVE INVERTER WITH 125 AMP CHARGER



WATER MANIFOLD SYSTEM
OFFERING POINT TO POINT CONNECTIONS, EQUALIZED WATER PRESSURE & TEMPERATURE, AND THE ABILITY TO ISOLATE ANY ISSUE



AQUA HOT HYDRONIC HEAT
PROVIDES EVEN HEATING THROUGHOUT THE COACH, ALONG WITH INSTANT HOT WATER, WHILE ALSO MAKING THIS COACH AN ALL ELECTRIC COACH

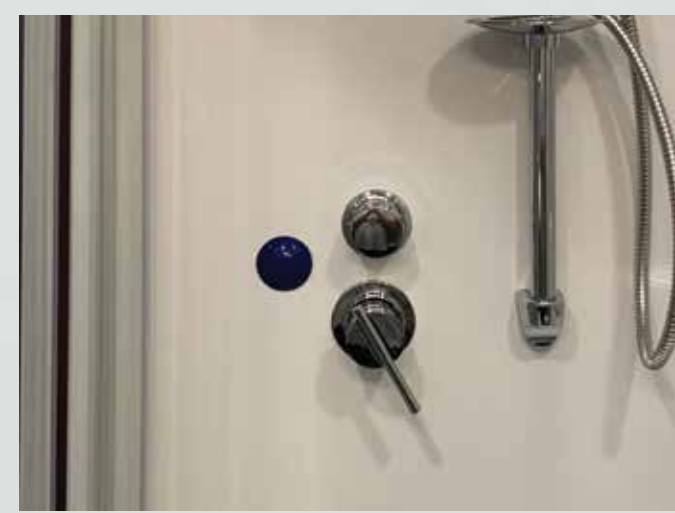

SHOWER MISER SYSTEM
EXTENDED STAY TECHNOLOGY HELPS INCREASE GRAY WATER TANK CAPACITY WHEN DRY CAMPING



PASSENGER WORK STATION
STOW AWAY PASSENGER SIDE WORK TABLE



WIRELESS PHONE CHARGE
DRIVER CONSOLE INDUCTION CHARGER



MULTIPLEX CONTROL
PRECISION CIRCUITS MULTIPLEX SYSTEM WITH PRECISION PLEX APP



GOLD HEAT® HEATED FLOORS
ELECTRIC HEATED LIVING ROOM AND KITCHEN FLOORS



SUSPENDED PEDALS
OFFERS A BETTER VIEW OF THE GAUGES, CONVENIENT ACCESS TO CONTROLS AND A MORE AUTOMOTIVE LOOK

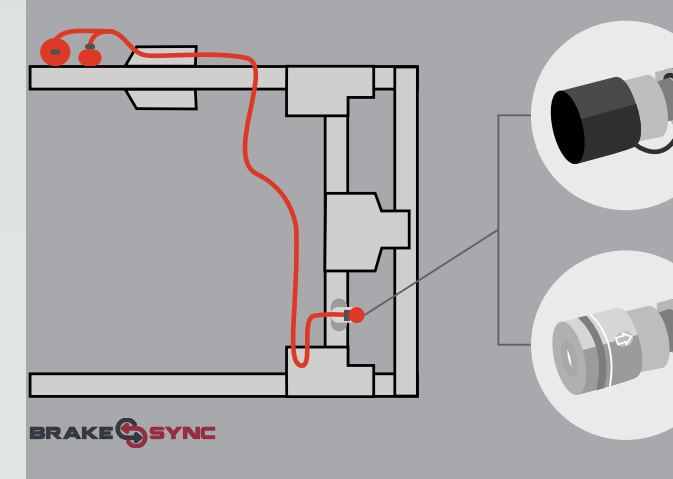

BRAKE SYNC
CONTINUOUS INNOVATION IN SAFETY SYSTEMS. FACTORY-WARRANTED SUPPLEMENTAL BRAKING SYSTEM

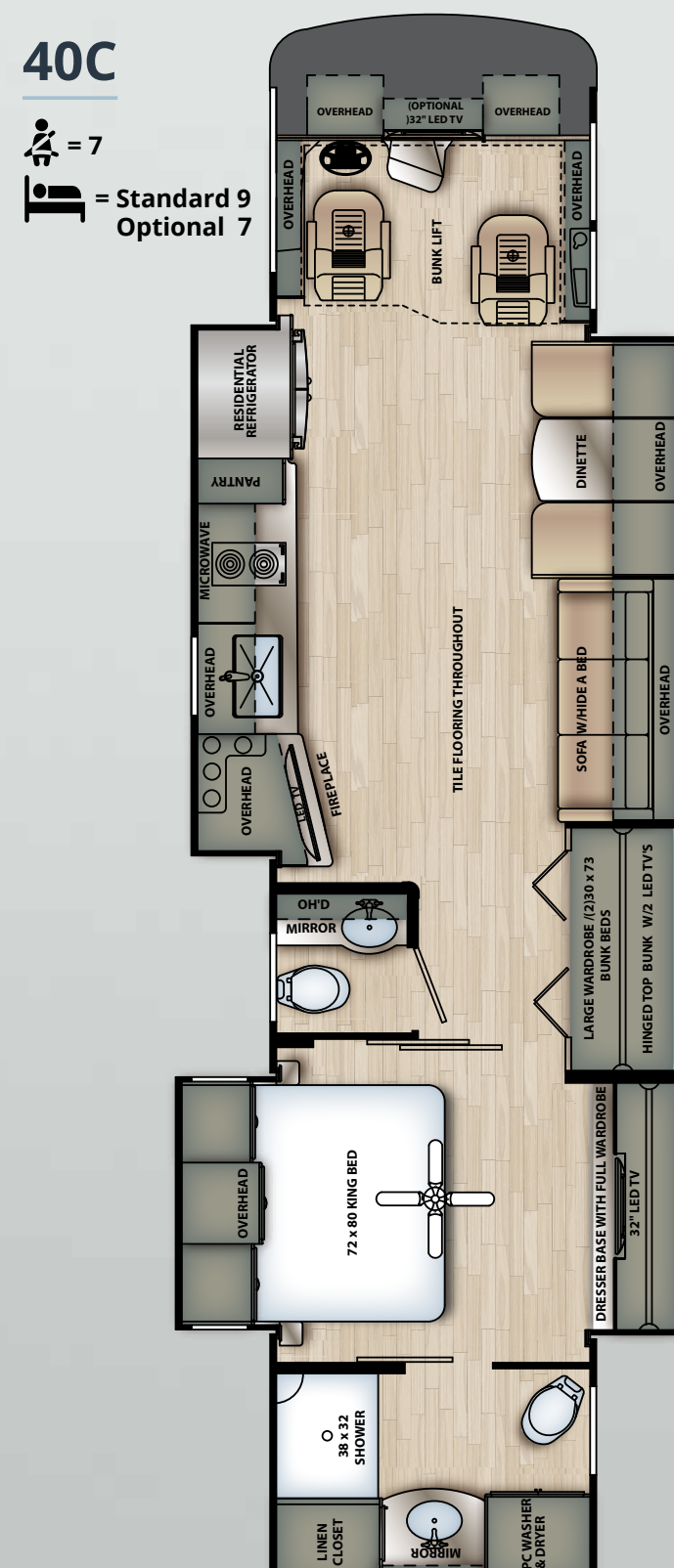

CONVENIENCE STANDARD PACKAGE FEATURES

- 1 KEYLESS ENTRY
- 2 1000W SOLAR PANEL
- 3 ENHANCED DASH RADIO AMPLIFIER
- 4 WIFI EXTENDER

STANDARD & OPTIONAL FEATURES

- + 3 Door Residential Refrigerator
- + Hardwood Cabinetry Throughout The Coach
- + Drop Down Euroloft Cab Over Bunk, 500 Lbs Capacity
- + Solid Surface Countertops With Lighted Edge In Kitchen
- + Electric Heated Tile Floors in Kitchen/Living room
- + BASF Full Body Paint With 4x The Clear Coat
- + Diamond Shield Front Mask Protective Film
- + Central Vacuum System
- + Bedroom Ceiling Fan
- + Smart TVs Throughout (Excluding Bunk TVs)
- + High Definition Cat6 Matrix Signal Distribution
- + JBL Sound Bar w/Integrated Sub & Bluetooth
- + High End Ultrafab Furniture Material
- + Three 15K BTU low profile Air conditioners (Front and Rear with heat pumps) on 40' Floorplans (N/A 37A)
- + 10" Dash radio w/ color back-up and side view camera pkg with Navigation & Apple CarPlay™
- + Carefree Latitude Dual Pitch Awning With LED Light & Wind Sensor
- + Electronic Safe
- + 30" Wide Entry Way, With True Diesel Motorhome Entry Door
- + Slide Tray In Basement Storage Compartment
- + Variable 4 GPM Water Pump
- + Electric Fireplace In Living Room
- + Heated Holding Tanks w/Forced Air Duct From Aqua Hot
- + Day/Night Roller Shades Throughout The Coach
- + Optional Stackable Washer And Dryer
- + Optional Power Theater Seating
- + Optional Winegard HD Traveler Satellite System
- + Optional Stainless Steel Dishwasher



Scan the QR Code to learn more about Berkshire Motorhomes.

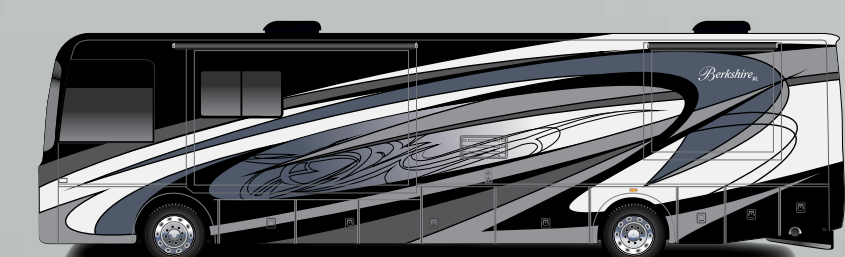

GLAZED ICE

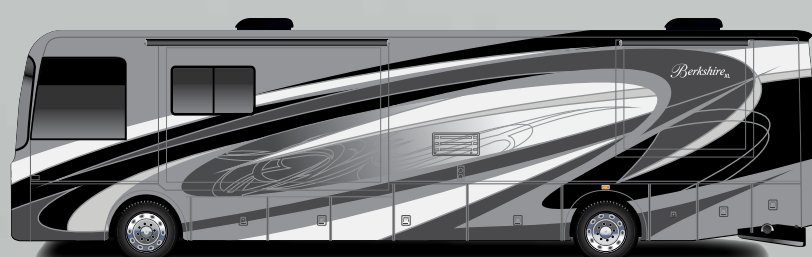

ASH ONYX



MANITOU

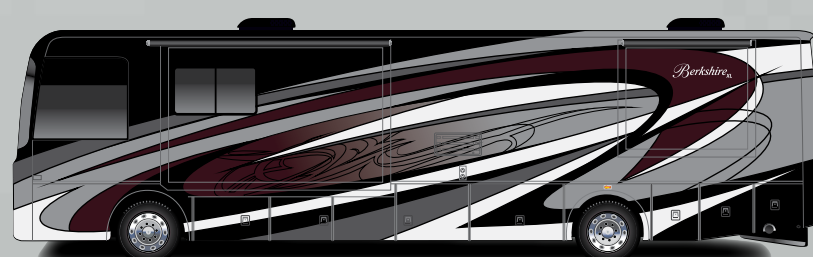

METEOR

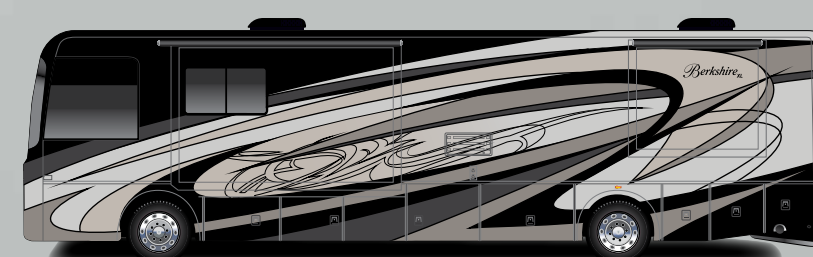

WARM STONE