

GREYSTONE

26 IN. ELECTRIC FIREPLACE

MODEL#F2611E

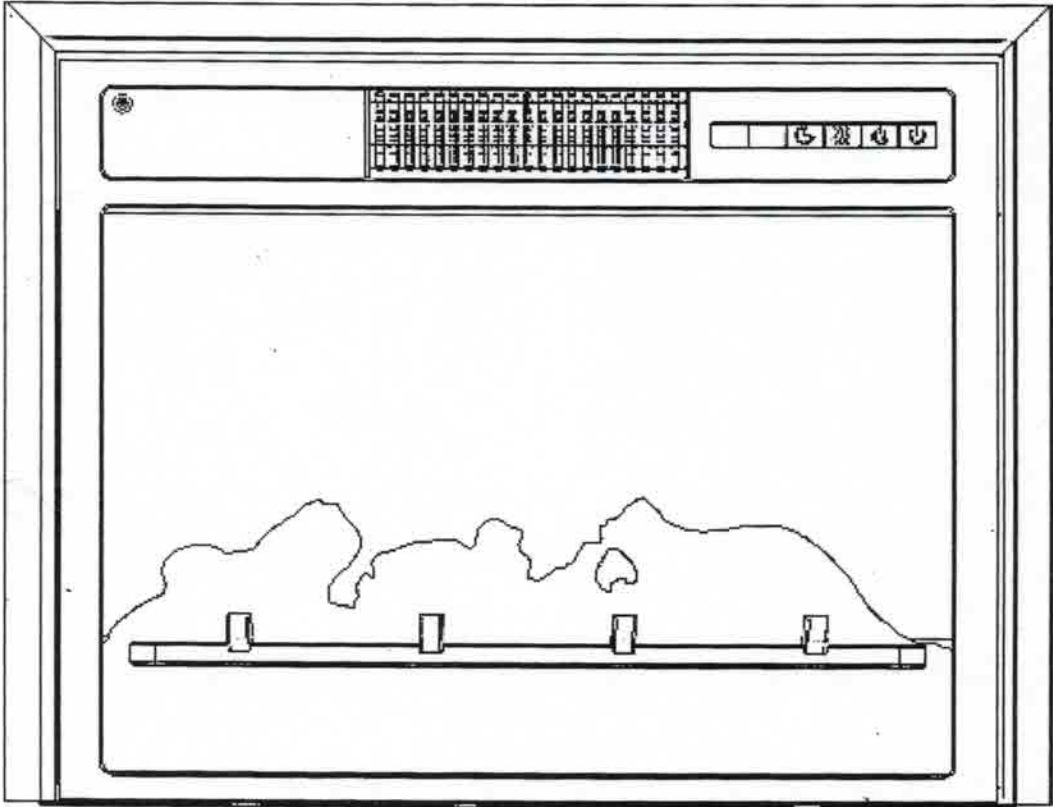

C US

TABLE OF CONTENTS

Safety Information	3
Operation Instructions	4
Installation Instructions	5
Care and Maintenance	6
Troubleshooting	7



SAFETY INFORMATION

Please read and understand this entire manual before attempting to assemble, operate or install the product.



WARNING: Any use of this appliance other than that recommended by the manufacturer in this owners manual may cause fire, burns, electric shock and/or other serious injuries or death.

When using electrical appliances, basic precautions should always be followed to reduce the risk of fire, electric shock and injury to persons including the following:

1. Read the manufacturers instructions completely before using this appliance.
2. This appliance will become hot when in use. To avoid burns, do not let bare skin touch hot surfaces. The grill at the top of this heater in particular will become hot when the heater is active. Take special care not to block the air intake or exhaust vents.
3. Extreme caution is necessary when the appliance is used by or near children or invalids and whenever the heater is left operating and unattended.
4. Do not operate the heater if the power cord or plug has been damaged or the heater has been damaged or malfunctioned in any way. Take the appliance to an authorized service facility for examination, electrical or mechanical adjustment or repair.
5. Do not use outdoors.
6. This heater is not intended for use in bathrooms, laundry areas and similar indoor locations. Never locate heater where it may fall into a bathtub or other water container.
7. To disconnect the appliance, turn all controls "OFF", and then remove the plug from the electrical outlet.
8. The appliance comes equipped with a 3 prong-grounding plug. Do not cut the grounding prong. Connect to properly grounded 120V outlets only.
9. Do not insert or allow foreign objects to enter any ventilation or exhaust openings as this may cause an electric shock or fire, or damage the appliance.
10. To prevent a possible fire, do not block air intakes or exhausts in any manner. Do not use on soft surfaces, like a bed, where openings may become blocked.
11. All electrical heaters have hot and arcing or sparking parts inside. Do not use in areas where gasoline, paint, or flammable liquids are used or stored or where the appliance will be exposed to flammable vapors.
12. Avoid using the appliance with an extension cord. Extension cords may overheat and cause a risk of fire. If an extension cord MUST be used, the cord must be No. 16AWG minimum size and rated not less than 1875 Watts. The extension cord must be a 3-prong cord with grounding type plug and cord connection and should not exceed 20' (6m) in length.
13. When transporting or storing the heater, take care to keep both the unit and power cord/plug dry, free from excessive vibration and away from heat sources.
14. Use the heater only as described in this manual. Any other use not recommended by the manufacturer may cause fire, electric shock, or injury to persons.
15. Do not attempt to burn wood or other materials in this heater.

OPERATING INSTRUCTIONS:

Read all instructions and warning prior to operating the appliance.

Ensure that all controls are in the "OFF" position before plugging the appliance in to a properly grounded electrical outlet.

The control panel of the appliance is located behind the wire grate above the window on the front (Fig. 1).

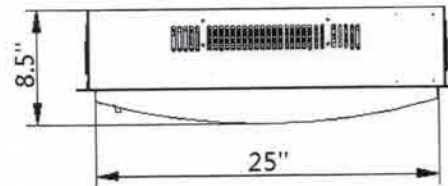
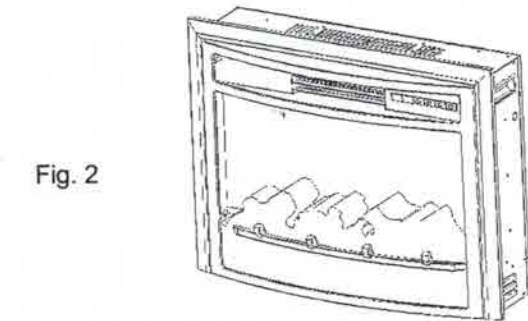
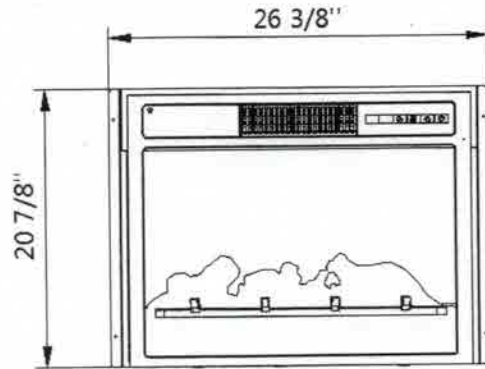
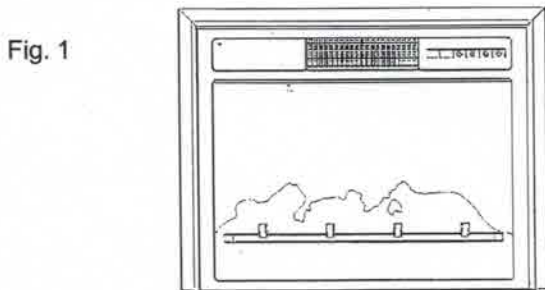

TO ACCESS CONTROL PANEL

Control panel can be accessed at upper-right corner of insert.



 — **POWER**

After unit is plugged the power ,Press the power button first time,starting up , touch it second time, the power shut down .

 — **FLAME**

Flame brightness. Each time the flame button is Pressed, the intensity of the flame decreases. There are 5 brightness levels you can cycle through and the OFF setting .

 — **HEATER**

Temperature setting. The highest temperature of thermostat is 95F°, there are 7 thermostat levels(95 F°,90 F°,85 F°,80F°,75 F°,70 F°,65 F°,) you can cycle through and the OFF setting .



Trim Kits Installation:

(Model No: FT26)

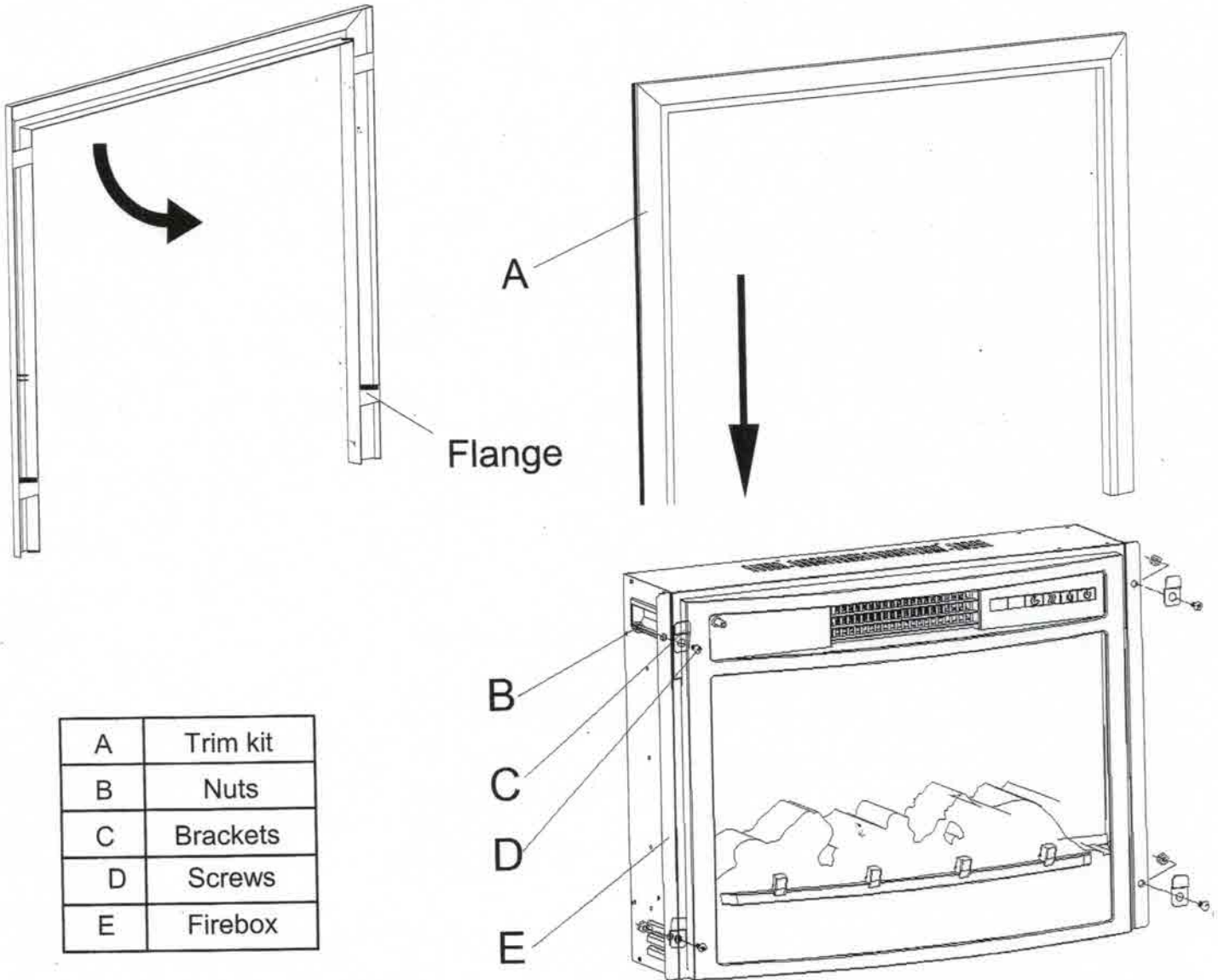

1. Attach the 4 brackets (C) in the holes located on either sides of the fireplace face using the screws (D) and nuts (B) as shown.
2. Slide the trim kit (A) onto the brackets (C). The flanges will fit behind the brackets.
3. Gently push the trim kit down until fully seated.



— TIMER

Timer setting . Press the TIMER button will cycle through the 9 timer settings(30minutes, 1 Hour,2H,3H,4H,5H,6H,7H,and 8H) and the OFF setting.

Note: When a function is changed from the control panel or remote control there will be a corresponding indicator (see Figure2) on the upper-right of the projection screen. The indicator shows the function changed and the level selected by the control panel or remote control. When the function is turned off, the corresponding indicator will flash several times and then fade off.

REPLACING THE REMOTE CONTROL BATTERY

When the remote control stops operating or its range seems reduced, it is time to replace the battery with a new one.

1. The battery compartment is located on the back end of the remote.
2. Press and slide the battery door open and remove the old battery.
3. Insert a CR2025 battery, checking that the "+" and "-" terminals of the battery matches the inside of the battery compartment.
4. Replace the battery compartment door.

Note: Do not mix old and new batteries.

Do not mix alkaline, standard (carbonzinc), or rechargeable (nicad, nimh, ect) batteries. Flame and/or heat can work separately or together.

INSTALLATION INSTRUCTIONS

PLUGGING IN THE HEATER(Refer to Fig.4):

This heater is for use on 120 Volts. The heater has a 3-prong grounded plug (fig. A). If your electrical outlet has only 2 slots (fig. B), you will have to use an adapter (fig. C) to convert from the 3-prong power cord to a 2-slot receptacle. The green grounding plug extending from the adapter must be securely connected to a permanent ground such as a properly grounded outlet box. The adapter should only be used if a proper 3-slot receptacle is not available .

NOTE: Adapters are not allowed for use in Canada.

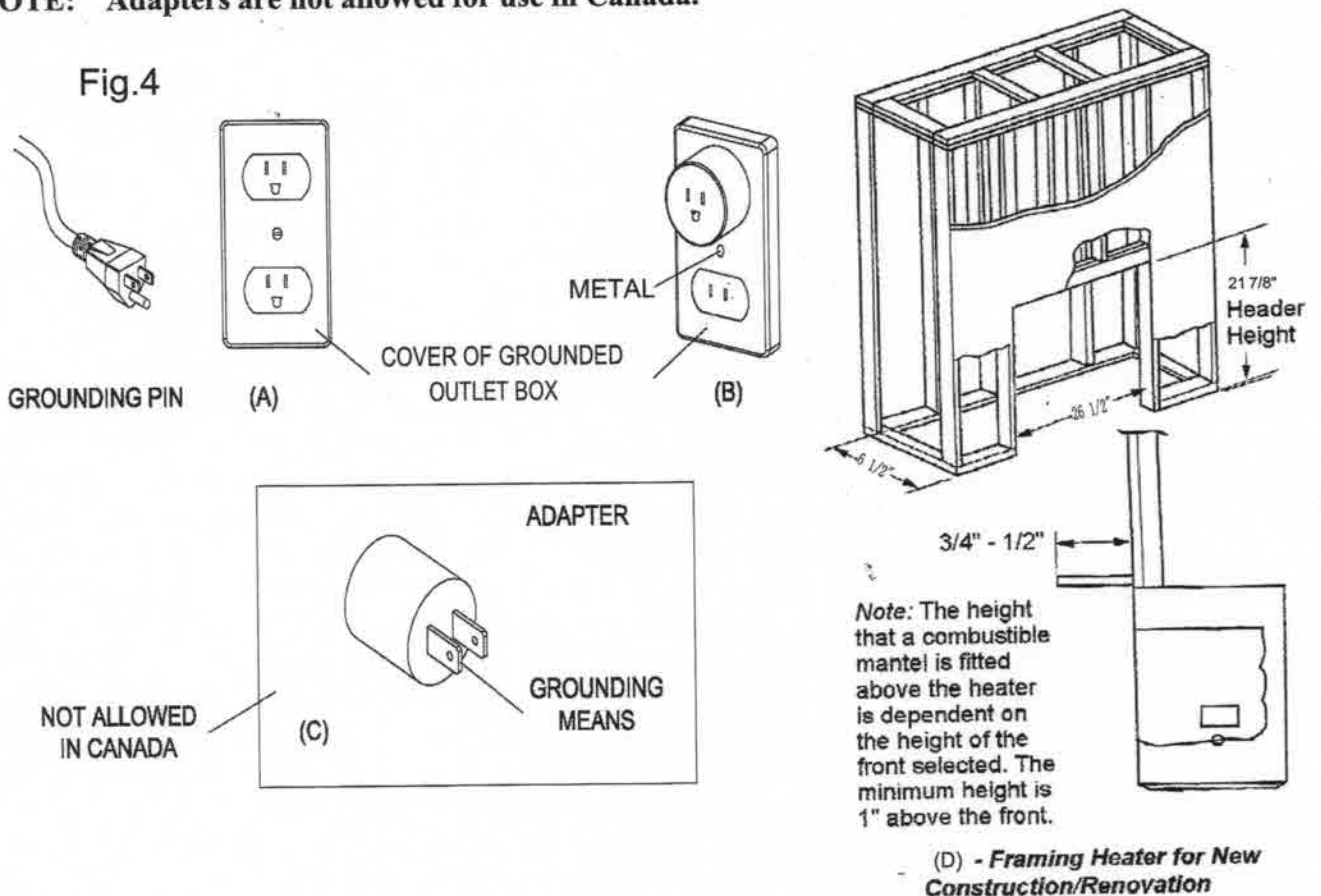

A 15 AMP circuit is required to operate this appliance. If the breaker trips when the appliance is running, you may need to move the appliance to another location or unplug other appliances that are on the same circuit.

CARE AND MAINTENANCE

- ⚠ WARNING:** Before attempting to perform any maintenance on this appliance, turn all controls to the “OFF” position and unplug. Allow the appliance to be “OFF” for at least 10 minutes before performing any maintenance in order to allow all components to cool properly.

Replacing Light Bulbs:

- Make sure that all controls are off and that the appliance is unplugged.
- Wear latex gloves to ensure that grease/oil from your hands does not transfer to the bulbs.
- Remove 2 screws on the bulb panel (See Fig.5). Fold and remove the bulb panel (See Fig.6). You can see three 40W light bulbs in the firebox (See Fig.7).
- Examine the light bulbs to determine which bulbs require replacement.
- Remove the burnt out bulb and replace with a new 40W bulb –do not over tighten.
- Place the bulb panel to the original position and tighten the back panel by 2 screws (See Fig.8).

- ⚠ WARNING:** DO NOT EXCEED THE RECOMMENDED BULB WATTAGE.

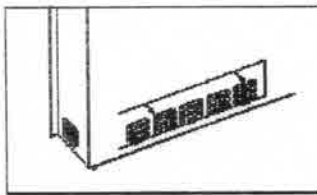

Fig.5

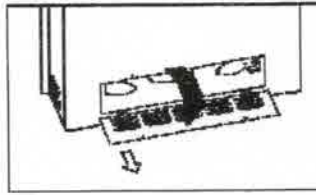

Fig.6

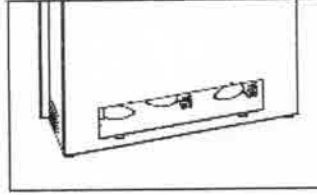

Fig.7

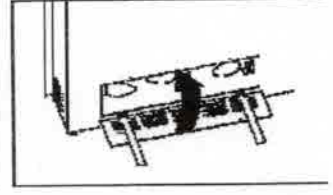

Fig.8

Cleaning:

- To remove dust from glass window, use clean dry cloth.
- To remove fingerprints or other marks from glass window, use clean damp cloth. Do not spray glass cleaner or other liquids directly onto the window.
- Clean metal surfaces with a clean damp cloth making sure not to push dust or debris into any air intake or exhaust vents.
- Do not use abrasive cleaners or spray liquids on any part of the appliance.
- Periodic cleaning/vacuuming of the fan/heater unit is strongly recommended to ensure that no dirt or foreign objects build up.

TROUBLESHOOTING

⚠ WARNING: Turn off the appliance, unplug and let cool for at least 10 minutes before attempting to service. Only a qualified professional should attempt to service or repair the appliance.

Problem	Possible Cause	Corrective Action
	<ol style="list-style-type: none"> 1. Dimmer control button is set too low. 2. Light bulbs are burned out. 3. "Flame wand" has come loose from bracket. 4. "Flame wand" motor is not functioning. 	<ol style="list-style-type: none"> 1. Push button E "+" to increase light. 2. Inspect light bulbs and replace if necessary. (see Maintenance section of this manual) 3. Remove back panel. Secure end of "flame wand" back into the support bracket. 4. Call for Technical Service.
The appliance turns off and will not turn back on	<ol style="list-style-type: none"> 1. The overheat protection device in the appliance has been triggered. 2. House circuit breaker has been tripped. 	<ol style="list-style-type: none"> 1. Turn all controls off, unplug the appliance, allow to cool for at least 10 minutes, then plug back in and restart. 2. Reset house circuit breaker.
The appliance does not turn on when the button is pushed to "ON"	<ol style="list-style-type: none"> 1. The overheat protection device in the appliance has been triggered. 	<ol style="list-style-type: none"> 1. Turn all controls off, unplug the appliance, allow to cool for at least 10 minutes, then plug back in and restart.
Remote control does not work	<ol style="list-style-type: none"> 2. Low batteries. 3. Manual controls on the appliance must be "ON" before operating the remote control. 	<ol style="list-style-type: none"> 1. Replace all batteries in the remote control. 2. Push the appliance "ON" using the manual control panel, then use remote control to operate. If using the remote control to operate the appliance, you must also turn the appliance "ON" using the remote control.