

GREYSTONE

36 IN ELECTRIC FIREPLACE

MODEL# SF103-35

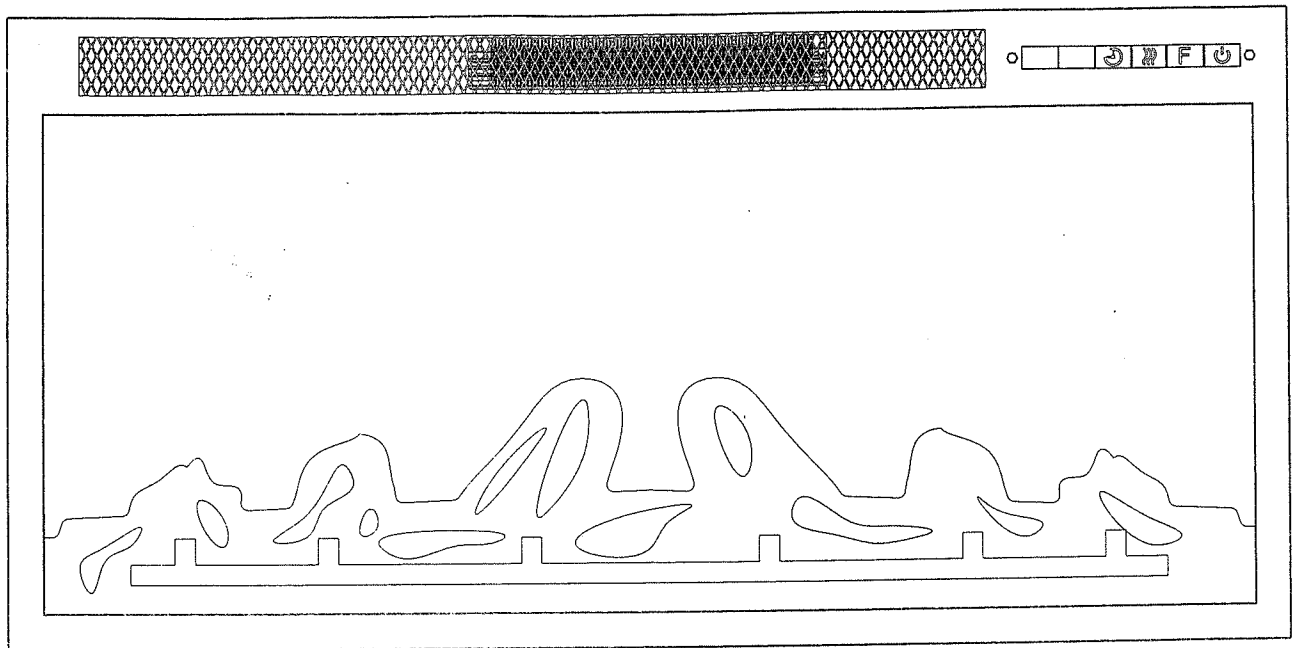



TABLE OF CONTENTS

Safety Information.....	3
Preparation.....	4
Preparation (Trim Kit Installation).....	5
Operating Instruction.....	6
Care and Maintenance.....	7
Troubleshooting.....	8

SAFETY INFORMATION

Please read and understand this entire manual before attempting to assemble , operate or install the product.

 **WARNING:** Any use of this appliance other than that recommended by the manufacturer in this owners manual may cause fire, burns, electric shock and/or other serious injuries or death.

When using electrical appliances, basic precautions should always be followed to reduce the risk of fire, electric shock and injury to persons including the following:

1. Read the manufacturers instructions completely before using this appliance.
2. This appliance will become hot when in use. To avoid burns, do not let bare skin touch hot surfaces. The grill at the top of this heater in particular will become hot when the heater is active. Take special care not to block the air intake or exhaust vents.
3. Extreme caution is necessary when the appliance is used by or near children or invalids and whenever the heater is left operating and unattended.
4. Do not operate the heater if the power cord or plug has been damaged or the heater has been damaged or malfunctioned in any way. Take the appliance to an authorized service facility for examination, electrical or mechanical adjustment or repair.
5. Do not use outdoors.
6. This heater is not intended for use in bathrooms, laundry areas and similar indoor locations. Never locate heater where it may fall into a bathtub or other water container.
7. To disconnect the appliance, turn all controls "OFF", and then remove the plug from the electrical outlet.
8. The appliance comes equipped with a 3 prong-grounding plug. Do not cut the grounding prong. Connect to properly grounded 120V outlets only.
9. Do not insert or allow foreign objects to enter any ventilation or exhaust openings as this may cause an electric shock or fire, or damage the appliance.
10. To prevent a possible fire, do not block air intakes or exhausts in any manner. Do not use on soft surfaces, like a bed, where openings may become blocked.
11. All electrical heaters have hot and arching or sparking parts inside. Do not use in areas where gasoline, paint, or flammable liquids are used or stored or where the appliance will be exposed to flammable vapors.
12. Avoid using the appliance with an extension cord. Extension cords may overheat and cause a risk of fire. If an extension cord MUST be used, the cord must be No. 16AWG minimum size and rated not less than 1875 Watts. The extension cord must be a 3-prong cord with grounding type plug and cord connection and should not exceed 20' (6m) in length.
13. When transporting or storing the heater, take care to keep both the unit and power cord/plug dry, free from excessive vibration and away from heat sources.
14. Use the heater only as described in this manual. Any other use not recommended by the manufacturer may cause fire, electric shock, or injury to persons.
15. Do not attempt to burn wood or other materials in this heater.

PREPARATION

⚠ CAUTION: This heater has front panel made of GLASS! Always use extreme caution when handling glass. Failure to do so could result in personal injury or personal damage.

This heater is for use on 120 Volts. The heater has a 3-prong grounded plug (Figure 2. A). If your electrical outlet has only 2 slots (Figure 2. B), you will have to use an adapter (Figure 2. C) to convert from the 3-prong power cord to a 2-slot receptacle. The green grounding plug extending from the adapter must be securely connected to a permanent ground such as a properly grounded outlet box. The adapter should only be used if a proper 3-slot receptacle is not available.

NOTE: Adapters are not allowed for use in Canada.

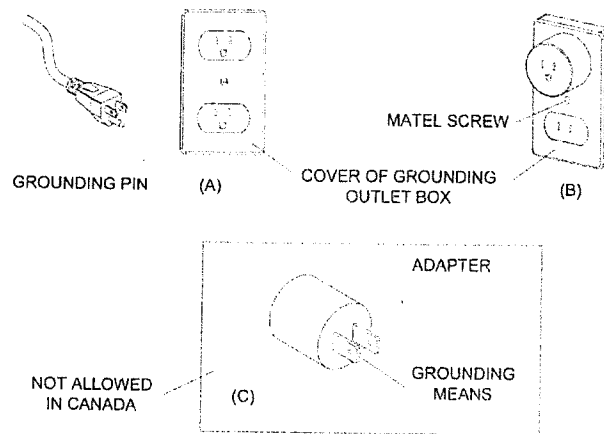

A 15 AMP circuit is required to operate this appliance. If the breaker trips when the appliance is running, you may need to move the appliance to another location or unplug other appliances that are on the same circuit.

PREPARATION

Installation:

Please assemble on soft and clean surface to prevent damage or scratch.

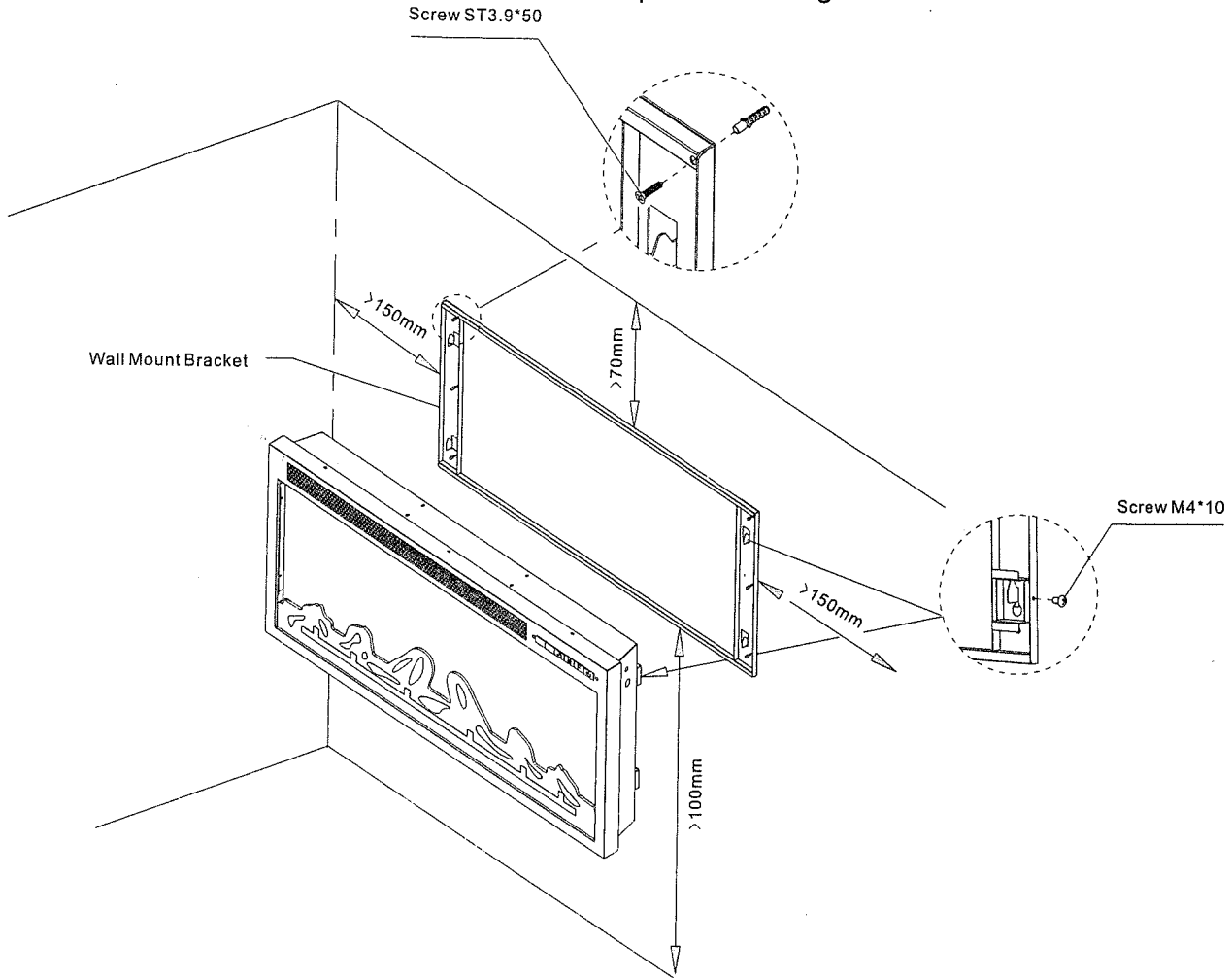

1. Start with wall mount bracket and select the area where you want the fireplace to be mounted.
2. Secure the wall bracket to the wall using ST3.9*50 screws.
3. Lift the fireplace, line up the 4 holes on fireplace bracket with wall bracket, insert and let easily slide down.
4. Use 2 pieces M4 screws to secure the fireplace from moving.

OPERATING INSTRUCTION

Read all instructions and warning prior to operating the appliance. Ensure that all controls are in the "OFF" position before plugging the appliance in to a properly grounded electrical outlet. Flame and heater can be presenting separately or at the same time.

The Fireplace control functions can be accessed in two ways :

1. Using the touchpad control panel, located on the upper right-hand of the fireplace (Figure 4)
2. Using the multi-function remote control (Figure 5), functions same as control panel

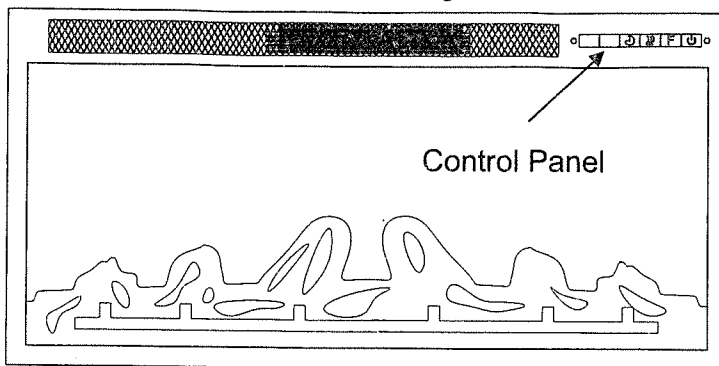

Figure 4

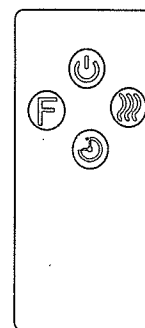

Figure 5

Using the Control Panel

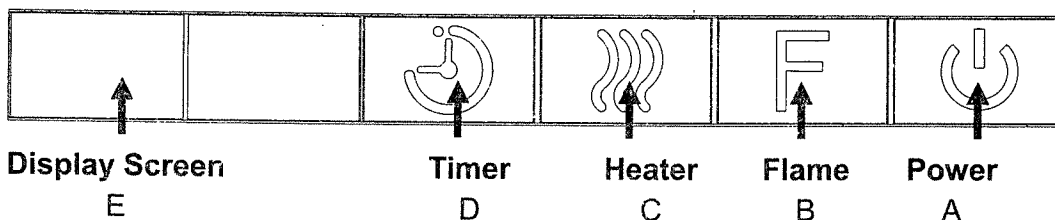

Figure 6

Power(Figure 6.A):

Press the POWER button to turn on the unit. Press again to turn off the unit. As long as the unit is powered on, the log-set will be alight and all functions are accessible.

F Button (Flame button)(Figure 6.B):

F button controls the brightness of flame effect from the highest to lowest setting. There are 9 levels of the flame brightness.

Heater(Figure 6.C):

Press once to activate the Low Heat Setting(L), press the button a second time to activate the High Heat Setting(H), and a third time to activate the "Auto" function(A). Once the heater is activated, a blue indicator light will appear until heater reaches desired setting. The highest temperature of thermostat is 95° F and the lowest is 65° F. Once the HEATER is activated , the display screen(Figure 6.E), will display the heater setting in use.You may turn off the HEATER using this button as well.

Timer(Figure 6.D):

Press once to activate the TIMER. Use the TIMER to have the unit turn off automatically after 30 minutes or up to 9 hours.The display screen(Figure 6.E) will display the setting shortly.

CARE AND MAINTENANCE

⚠WARNING: Before attempting to perform any maintenance on this unit, turn all controls to the "OFF" position and unplug. Allow the unit to be "OFF" for at least 10 minutes before any maintenance applied in order to allow all components to cool down properly.

Cleaning:

1. To remove dust, fingerprints or other marks from glass window, use clean damp cloth. Do not spray glass cleaner or other liquids directly onto the glass.
2. Clean metal surfaces with a clean damp cloth making sure not to push dust or debris into any air intake or exhaust vents.
3. Do not use abrasive cleaners or spray liquids on any part of the appliance.
4. Periodic cleaning/vacuuming of the fan/heater unit is strongly recommended to ensure that no dirt or foreign objects build up.

Replacing Remote Control Battery

If the remote controls stops functioning or operate poorly, the battery should be replaced with new one (model#CR2025).

1. The battery compartment can be found on the back side of the remote control.
2. Press and slide the battery door to open and remove the old battery.
3. Insert a new CR2025 coin battery, making sure that the polarity "+" and "-" matches properly as illustration showing.
4. Close the battery door.

Replacing Light Bulb

⚠WARNING: DO NOT EXCEED THE RECOMMENDED BULB WATTAGE.

1. Make sure that all controls are off and that the appliance is unplugged.
2. Wear latex gloves to ensure that the grease/oil from your hands and doesn't transfer to bulbs.
3. Remove 3 screws on the service window panel. (Figure 7. A)
4. Fold and remove the service window panel.
5. Remove the burnt out light bulb and replace with a new 40W light bulb. **WARNING:** Do NOT exceed the recommended bulb wattage.
Hand tighten the bulbs only - do NOT over tighten. (Figure 7. B)
6. Place the service window panel to the original position and tighten it by 3 screws (Figure 7. C)

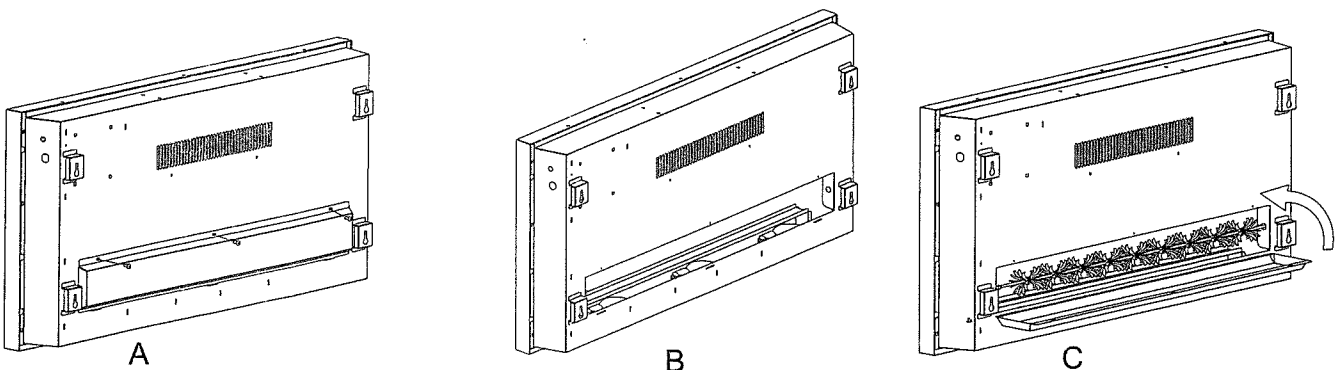

Figure 7

Trouble Shooting

⚠️WARNING: Turn off the unit, unplug and allow the unit to cool for at least 10 minutes before attempting to perform any service. Only a qualified professional should attempt to service or repair the unit.

PROBLEM	POSSIBLE CAUSE	SOLUTION
Simulated flame is dim or not presenting	<ol style="list-style-type: none"> 3. Flame setting incorrect 2. "Flame wand" has come loose from bracket. 3. "Flame wand" driving motor is not functioning. 4. Light bulb are burnt out 	<ol style="list-style-type: none"> 1. Reset flame 2. Remove screws holding back panel in place and remove back panel. Secure end of flame wand back into the support bracket. 3. Call for Technical Service. 4. Inspect light bulbs and replace if necessary. (See "Replacing Light Bulb" on "Care and maintenance")
The appliance turns off and will not turn back on	<ol style="list-style-type: none"> 1. The overheat protection device in the appliance has been triggered. 2. House circuit breaker has been tripped. 	<ol style="list-style-type: none"> 1. Turn off and unplug the appliance, allow the insert to cool down for at least 10 minutes, then plug in and restart. 2. Reset house circuit breaker.
The appliance does not turn on when the appliance setup to be "ON"	<ol style="list-style-type: none"> 1. The overheat protection device in the appliance has been triggered. 	<ol style="list-style-type: none"> 1. Turn off and unplug the appliance, allow the insert to cool down for at least 10 minutes, then plug in and restart.
Remote Control does not work	<ol style="list-style-type: none"> 1. Low batteries. 2. Turn on the unit by control panel manually before using remote control 	<ol style="list-style-type: none"> 1. Replacing with new battery 2. Turn on the unit by control panel manually before using remote control