

# Over The Range Microwave Oven

## Use & Care Guide

Model AMV6167BD

<b>IMPORTANT SAFETY INSTRUCTIONS</b> .....	<b>2</b>
<b>Precautions to Avoid Possible Exposure to Excessive Microwave Energy</b> .....	<b>4</b>
<b>Getting The Best Cooking Results</b> .....	<b>6</b>
<b>Features</b> .....	<b>7</b>
<b>Operating Instructions</b> .....	<b>9</b>
<b>Cooking Utensils</b> .....	<b>29</b>
<b>Care and Cleaning</b> .....	<b>30</b>
<b>Troubleshooting</b> .....	<b>32</b>
<b>AMANA® MAJOR APPLIANCE WARRANTY</b> .....	<b>34</b>
<b>Guide d'utilisation et d'entretien</b> .....	<b>35</b>
<b>Guía de uso y cuidado</b> .....	<b>69</b>

Keep instructions for future reference.  
Be sure Use & Care Guide stays with oven.

# IMPORTANT SAFETY INSTRUCTIONS

Installer: Please leave this guide with this appliance.  
Consumer: Please read and keep this Use & Care Guide for future reference.

Keep sales receipt and/or canceled check as proof of purchase.

Model Number \_\_\_\_\_

Serial Number \_\_\_\_\_

Date of Purchase \_\_\_\_\_

In our continuing effort to improve the quality and performance of our appliances, it may be necessary to make changes to the appliance without revising this guide.

If you have questions, write us (include your model number and phone number) or call:

Maytag Services<sup>LLC</sup>

Attn: CAIR<sup>®</sup> Center

P.O. Box 2370

Cleveland, TN 37320-2370

1-800-843-0304 U.S.A

1-800-807-6777 Canada

1-800-688-2080 (US TTY for hearing or speech impaired)

(Mon.-Fri., 8 a.m.-8 p.m. Eastern Time)

Internet: <http://www.amana.com>

## WHAT YOU NEED TO KNOW ABOUT SAFETY INSTRUCTIONS

Warning and Important Safety Instructions appearing in this Use & Care Guide are not meant to cover all possible conditions and situations that may occur. Common sense, caution, and care must be exercised when installing, maintaining, or operating microwave.

Always contact your dealer, distributor, service agent, or manufacturer about problems or conditions you do not understand.

## RECOGNIZE SAFETY SYMBOLS, WORDS, LABELS

### DANGER

**DANGER** – Immediate hazards which **WILL** result in severe personal injury or death.

### ⚠ WARNING

**WARNING** – Hazards or unsafe practices which **COULD** result in severe personal injury or death.

### CAUTION

**CAUTION** – Hazards or unsafe practices which **COULD** result in minor personal injury.

### CAUTION

To avoid personal injury or property damage, observe the following:

1. **Do not** deep fat fry in oven. Fat could overheat and be hazardous to handle.
2. **Do not** cook or reheat eggs in shell or with an unbroken yolk using microwave energy. Pressure may build up and erupt. Pierce yolk with fork or knife before cooking.
3. Pierce skin of potatoes, tomatoes, and similar foods before cooking with microwave energy. When skin is pierced, steam escapes evenly.
4. **Do not** operate oven without load or food in oven cavity.
5. Use only popcorn in packages designed and labeled for microwave use. Popping time varies depending on oven wattage. **Do not** continue to heat after popping has stopped. Popcorn will scorch or burn. **Do not** leave oven unattended.
6. **Do not** use regular cooking thermometers in oven. Most cooking thermometers contain mercury and may cause an electrical arc, malfunction, or damage to oven.
7. **Do not** use metal utensils in oven.
8. **Never** use paper, plastic, or other combustible materials that are not intended for cooking.
9. When cooking with paper, plastic, or other combustible materials, follow manufacturer's recommendations on product use.
10. **Do not** use paper towels which contain nylon or other synthetic fibers. Heated synthetics could melt and cause paper to ignite.
11. **Do not** heat sealed containers or plastic bags in oven. Food or liquid could expand quickly and cause container or bag to break. Pierce or open container or bag before cooking.
12. To avoid pacemaker malfunction, consult physician or pacemaker manufacturer about effects of microwave energy on pacemaker.

## SAVE THESE INSTRUCTIONS

# IMPORTANT SAFETY INSTRUCTIONS

## ⚠ WARNING

To avoid risk of electrical shock or death, this oven must be grounded and plug must not be altered.

## GROUNDING INSTRUCTIONS

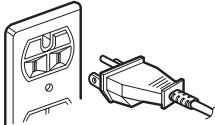

**Oven MUST be grounded.** Grounding reduces risk of electric shock by providing an escape wire for the electric current if an electrical short occurs. This oven is equipped with

a cord having a grounding wire with a grounding plug. The plug must be plugged into an outlet that is properly installed and grounded. See Installation Instructions.

Consult a qualified electrician or servicer if grounding instructions are not completely understood, or if doubt exists as to whether the oven is properly grounded.

**Do not use an extension cord.** If the product power cord is too short, have a qualified electrician install a three-slot receptacle. This oven should be plugged into a separate 60 hertz circuit with the electrical rating as shown in specifications table. When the oven is on a circuit with other equipment, an increase in cooking times may be required and fuses can be blown.

Microwave operates on standard household current, 110-120V.

## FEDERAL COMMUNICATIONS COMMISSION RADIO FREQUENCY INTERFERENCE STATEMENT (U.S.A. ONLY)

This equipment generates and uses ISM frequency energy and if not installed and used properly, that is in strict accordance with the manufacturer's instructions, may cause interference to radio and television reception. It has been type tested and found to comply with limits for ISM Equipment pursuant to part 18 of FCC Rules, which are designed to provide reasonable protection against such interference in a residential installation.

However, there is no guarantee that interference will not occur in a particular installation. If this equipment does cause interference to radio or television reception, which can be determined by turning the equipment off and on, the user is encouraged to try to correct the interference by one or more of the following:

- Reorient the receiving antenna of the radio or television.
- Relocate the microwave oven with respect to the receiver.
- Move the microwave oven away from the receiver.
- Plug the microwave oven into a different outlet so that the microwave oven and the receiver are on different branch circuits.

**The manufacturer** is not responsible for any radio or television interference caused by **unauthorized modification** to this microwave oven. It is the responsibility of the user to correct such interference.

## SAVE THESE INSTRUCTIONS

# IMPORTANT SAFETY INSTRUCTIONS

---

## PRECAUTIONS TO AVOID POSSIBLE EXPOSURE TO EXCESSIVE MICROWAVE ENERGY

- A. **DO NOT** attempt to operate this oven with the door open since open door operation can result in harmful exposure to microwave energy. It is important not to defeat or tamper with the safety interlocks.
- B. **DO NOT** place any object between the oven front face and the door or allow soil or cleaner residue to accumulate on sealing surfaces.
- C. **DO NOT** operate the oven if it is damaged. It is particularly important that oven door close properly and that there is no damage to:
  - 1. door (bent),
  - 2. hinges and latches (broken or loosened),
  - 3. door seals and sealing surfaces.
- D. Oven should not be adjusted or repaired by anyone except properly qualified service personnel.

### WARNING

Liquids such as water, coffee, or tea are able to be overheated beyond the boiling point without appearing to be boiling due to surface tension of the liquid. Visible bubbling or boiling when the container is removed from the microwave oven is not always present. **THIS COULD RESULT IN VERY HOT LIQUIDS SUDDENLY BOILING OVER WHEN A SPOON OR OTHER UTENSIL IS INSERTED INTO THE LIQUID.** To reduce the risk of injury to persons:

1. **Do not** overheat the liquid.
  2. Stir the liquid both before and halfway through heating it.
  3. **Do not** use straight-sided containers with narrow necks.
  4. After heating, allow the container to stand in the microwave oven for a short time before removing the container.
  5. Use extreme care when inserting a spoon or other utensil into the container.
- Important Safety Instructions for using the heater features.
6. Oversized foods or oversized metal utensils should not be inserted in microwave/convection oven as they may create a fire or electric shock.
  7. **Do not** clean with metal scouring pads. Piece can burn off the pad and touch electrical parts involving a risk of electric shock.
  8. **Do not** store any materials, other than manufacturer's recommended accessories, in this oven when not in use.
  9. **Do not** cover racks or any other part of oven with metal foil. This will cause overheating of the oven.

**SAVE THESE INSTRUCTIONS**

# IMPORTANT SAFETY INSTRUCTIONS

## ⚠ WARNING

When using electrical appliances, basic safety precautions should be followed to reduce the risk of burns, electric shock, fire, or injury to persons or exposure to excessive microwave energy.

1. **READ** all instructions before using oven.
2. **READ AND FOLLOW** the specific “PRECAUTIONS TO AVOID POSSIBLE EXPOSURE TO EXCESSIVE MICROWAVE ENERGY” on page 4.
3. Install or locate this oven **ONLY** in accordance with the installation instructions in this manual.
4. Some products such as whole eggs and sealed containers—for example, closed glass jars—are able to explode and **SHOULD NOT** be **HEATED** in this oven.
5. Use this oven **ONLY** for its intended use as described in this manual. Do not use corrosive chemicals or vapors in this oven. This type of oven is specifically designed to heat, cook, or dry food. It is not designed for industrial or laboratory use.
6. As with any appliance, **CLOSE SUPERVISION** is necessary when used by **CHILDREN** or **INFIRM PERSONS**.
7. See door cleaning instructions in the Care and Cleaning section on page 30.
8. Baby food jars shall be open when heated and contents stirred or shaken before consumption, in order to avoid burns.
9. **DO NOT** use this oven for commercial purposes. It is made for household use only.
10. **DO NOT** heat baby bottles in oven.
11. **DO NOT** operate this oven if it has a damaged cord or plug, if it is not working properly, or if it has been damaged or dropped.
12. This oven, including power cord, must be serviced **ONLY** by qualified service personnel. Special tools are required to service oven. Contact nearest authorized service facility for examination, repair, or adjustment.
13. **DO NOT** cover or block filter or other openings on oven.
14. **DO NOT** store this oven outdoors. **DO NOT** use this product near water – for example, near a kitchen sink, in a wet basement, near a swimming pool or similar locations.
15. **DO NOT** immerse cord or plug in water.
16. Keep cord **AWAY** from **HEATED** surfaces.
17. **DO NOT** let cord hang over edge of table or counter.
18. Clean the ventilating hood frequently.
19. **DO NOT** allow grease to accumulate on the hood or filters.
20. Use care when cleaning the ventilating hood filter. Corrosive cleaning agents such as lye-based oven cleaners may damage the filters.
21. When flaming foods under the hood, turn the fan on.
22. Suitable for use above both gas and electric cooking equipment 36 inches or less wide.

## CAUTION

To avoid risk of fire in the oven cavity:

- a. **DO NOT** overcook food. Carefully attend oven when paper, plastic, or other combustible materials are placed inside the oven to facilitate cooking.
- b. Remove wire twist-ties from paper or plastic bags before placing bag in oven.
- c. If materials inside the oven ignite, keep oven door **CLOSED**, turn oven off and disconnect the power cord, or shut off power at the fuse or circuit breaker panel.
- d. **DO NOT** use the cavity for storage. **DO NOT** leave paper products, cooking utensils, or food in the cavity when not in use.

## SAVE THESE INSTRUCTIONS

# Getting The Best Cooking Results

---

To get the best results from your microwave oven, read and follow the guidelines below.

- **Storage Temperature:** Foods taken from the freezer or refrigerator take longer to cook than the same foods at room temperature.
- **Size:** Small pieces of food cook faster than large ones, pieces similar in size and shape cook more evenly. For even cooking, reduce the power when cooking large pieces of food.
- **Natural Moisture:** Very moist foods cook more evenly because microwave energy is attracted to water molecules.
- **Stir** foods such as casseroles and vegetables from the outside to the center to distribute the heat evenly and speed cooking. Constant stirring is not necessary.
- **Turn over** foods like pork chops, baking potatoes, roasts, or whole cauliflower halfway through the cooking time to expose all sides equally to microwave energy.
- **Place** delicate areas of foods, such as asparagus tips, toward the center of the dish.
- **Arrange** unevenly shaped foods, such as chicken pieces or salmon steaks, with the thicker, meatier parts toward the outside of the dish.
- **Shield**, with **small** pieces of aluminum foil, parts of food that may cook quickly, such as wing tips and leg ends of poultry.
- **Let It Stand:** After you remove the food from the microwave, cover food with foil or casserole lid and let it stand to finish cooking in the center and avoid overcooking the outer edges. The length of standing time depends on the density and surface area of the food.
- **Wrapping in waxed paper or paper towel:** Sandwiches and many other foods containing prebaked bread should be wrapped prior to microwaving to prevent drying out.

# Features

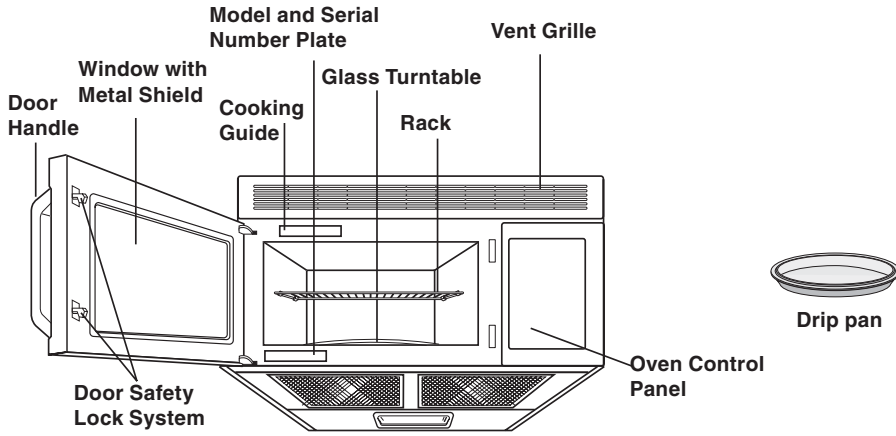

## OVEN SPECIFICATIONS

Power Supply	120 VAC, 60 Hz
Input Power	1,500W (USA, CANADA)
Cooking Power	950 W (IEC 60705 Standard)
Frequency	2,450 MHz
Rated Current	13 A (USA)
Outer Dimensions	29 <sup>7</sup> / <sub>8</sub> " (W) x 16 <sup>15</sup> / <sub>16</sub> " (H) x 15 <sup>7</sup> / <sub>16</sub> " (D)
Cavity Volume	1.6 Cu. Ft.
Net Weight	71 lbs.

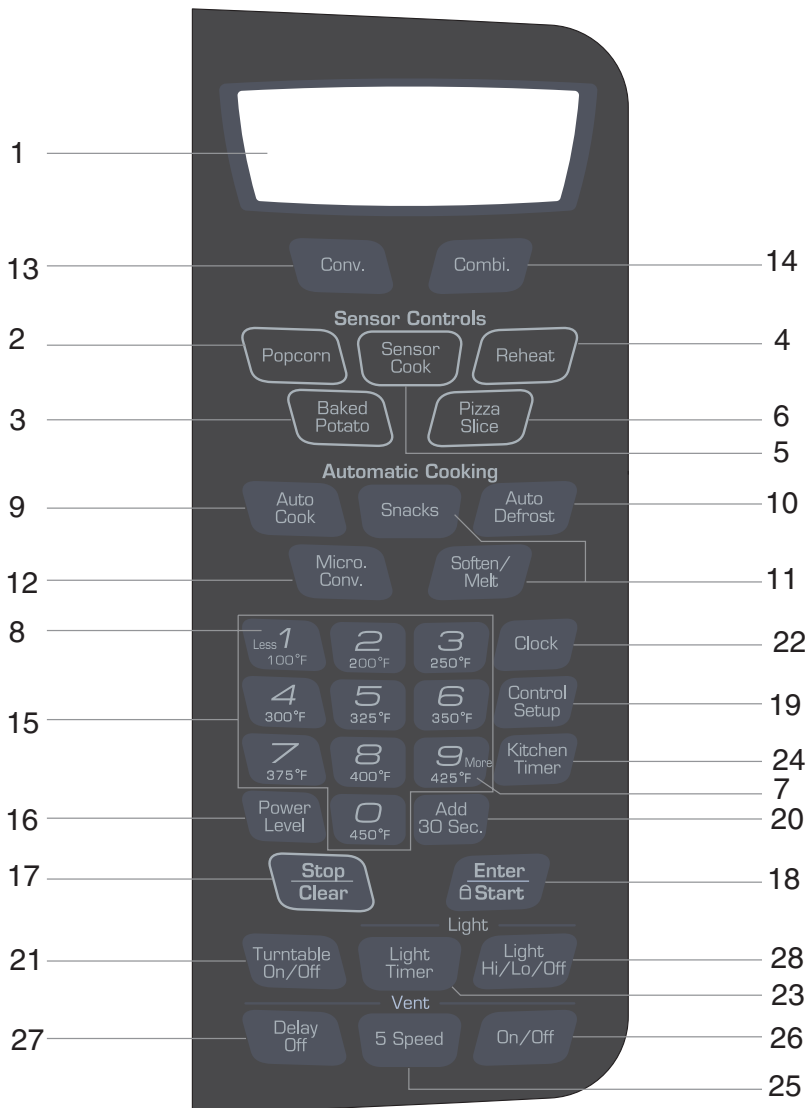



# Features

## FEATURES

- 1. DISPLAY:** The Display includes a clock and indicators to tell you time of day, cooking time settings and cooking functions selected.
- 2. POPCORN:** Touch this pad when popping popcorn in your microwave oven. The oven's sensor will tell the oven how long to cook depending on the amount of humidity it detects from the popcorn. See page 13 for more information.
- 3. BAKED POTATO:** Touch this pad to cook potatoes. The oven's sensor will tell the oven how long to cook depending on the amount of humidity it detects from the potato. See page 14 for more information.
- 4. REHEAT:** Touch this pad to reheat dinner plate, casserole, and pasta. The oven's sensor will tell the oven how long to cook depending on the amount of humidity coming from the food. See page 14 for more information.
- 5. SENSOR COOK:** Touch this pad to cook frozen vegetable, frozen breakfast, frozen dinner, fresh vegetable and shrimp. The oven's sensor will tell the oven how long to cook depending on the amount of humidity coming from the food. See page 14 for more information.
- 6. PIZZA SLICE:** Touch this pad to reheat pizza. The oven's sensor will tell the oven how long to cook depending on the amount of humidity it detects. See page 13 for more information.
- 7. MORE(9):** Touch this pad to add more cooking time. See page 10 for more information.
- 8. LESS(1):** Touch this pad to reduce cooking time. See page 10 for more information.
- 9. AUTO COOK:** Touch this pad to cook baby food, beverage, frozen sandwich, bacon and instant rice.
- 10. AUTO DEFROST:** Touch this pad to defrost food by weight. See page 17 for more information.
- 11. SNACKS, SOFTEN/MELT:** Touch these pads to cook specific food. See pages 18 and 19 for more information.
- 12. MICRO CONVECT:** Touch this pad to cook whole chicken, roast pork, frozen lasagna and baked potatoes.
- 13. CONVECTION:** Touch this pad when setting convection cooking.
- 14. COMBINATION COOKING:** Touch this pad when setting combination cooking.
- 15. NUMBER:** Touch number pads to enter cooking time, power level, quantities, or weights.
- 16. POWER LEVEL:** Touch this pad to select a cooking power level.
- 17. STOP/CLEAR:** Touch this pad to stop the oven or to clear all entries.
- 18. ENTER/START:** Touch this pad to start a function. If you open the door after oven begins to cook, close the door and touch **ENTER/START** pad again.
- 19. CONTROL SETUP:** Touch this pad to change the oven's default settings. See page 9 for more information.
- 20. ADD 30 SEC:** Touch this pad to set and start quickly at 100% power level. See page 10 for more information.
- 21. TURNTABLE ON/OFF:** Touch this pad to turn off the turntable. OFF will appear in the display. See page 9 for more information.
- 22. CLOCK:** Touch this pad to enter the time of day. See page 9 for more information.
- 23. LIGHT TIMER:** Touch this pad to set the light timer. See page 10 for more information.
- 24. KITCHEN TIMER:** Touch this pad to set the kitchen timer. See page 9 for more information.
- 25. VENT 5 SPEED:** Touch this pad to choose one of 5 fan speeds.
- 26. VENT ON/OFF:** Touch this pad to turn the fan on/off.
- 27. VENT DELAY OFF:** Touch this pad when setting ventilation time. (1, 3, 5, 10, 30 minutes)
- 28. LIGHT HI/LO/OFF:** Touch this pad to turn on the cooktop light. See page 10 for more information.

**NOTE:**

TURNTABLE ON/OFF is not available in sensor cook, auto cook and defrost modes.



# Operating Instructions

## LEARN ABOUT YOUR MICROWAVE OVEN

This section introduces you to the basics you need to know to operate your microwave oven. Please read this information before use.

### CAUTION

- To avoid risk of personal injury or property damage, do not run oven empty.
- To avoid risk of personal injury or property damage, do not use stoneware, aluminum foil, metal utensils, or metal trimmed utensils in the oven.

## CLOCK

**Example: To set 8:00 AM.**

- Clock
- 8 0 0  
400°F 450°F 450°F
- Enter  
Start
- 1  
Less  
100°F
- Enter  
Start
1. Touch **CLOCK** pad.
  2. Enter the time by using the number pads.
  3. Touch **ENTER/START** pad.
  4. Touch **1** for AM.
  5. Touch **ENTER/START** pad.

### NOTE:

- Follow steps 1-3 above in the 24 hour clock mode.

## KITCHEN TIMER

You can use your microwave oven as a timer. Use the Kitchen Timer for timing up to 99 minutes, 99 seconds.

**Example: To set for 8 minutes.**

- Kitchen  
Timer
- 8 0 0  
400°F 450°F 450°F
- Enter  
Start
1. Touch **KITCHEN TIMER** pad.
  2. Enter the time by using the number pads.
  3. Touch **ENTER/START** pad.

When the time is over, you will hear beeps and **END** will display.

## CONTROL SETUP

You can change the default values. See following chart for more information.

No.	Function	No.	Result
1	Weight mode selected	1 2	Lbs. Kg.
2	Sound ON/OFF control	1 2	Sound ON Sound OFF
3	Clock display control	1 2	12HR 24HR
4	Display	1 2 3	Slow speed Normal speed Fast speed
5	Remind end Signal	1 2	ON OFF
6	Demo Mode	1 2	ON OFF
7	Daylight Saving Time	1 2	ON OFF

**Example: To change weight mode (from Lbs. to Kg).**

- Control  
Setup
- 1  
Less  
100°F
- 2  
200°F
1. Touch **CONTROL SETUP** pad.
  2. Touch number **1** pad.
  3. Touch number **2** pad.

## VENT FAN

The VENT moves steam and other vapors from the cooking surface.

**Example: To set Level 4.**

- On/Off
- 5 Speed
1. Touch **ON/OFF** pad. This shows the last level until you select the fan speed level.
  2. Touch **5 SPEED** pad until Level 4 appears in the display.

Touch **ON/OFF** pad to turn off fan when desired.

### NOTE:

- If the temperature gets too hot around the microwave oven, the fan in the vent hood will automatically turn on at the **LEVEL2** setting to cool the oven. The fan will automatically turn off when the internal parts are cool. When this occurs, the vent cannot be turned off.

## DELAY OFF

**Example: To turn off fan after 30 minutes for Level 4.**

- On/Off
- 5 Speed
- Delay  
Off
1. Touch **ON/OFF** pad.
  2. Touch **5 SPEED** pad until Level 4 appears in the display.
  3. Touch **DELAY OFF** pad five times.

## TURNTABLE ON/OFF

For best cooking results, leave the turntable on. It can be turned off for large dishes.

- Turntable  
On/Off
- Touch **TURNTABLE ON/OFF** pad to turn the turntable on or off.

### NOTES:

- This option is not available in sensor cook, auto cook and defrost modes.
- **Sometimes the turntable can become hot to touch.** Be careful touching the turntable during and after cooking.
- **Do not run the oven empty.**

# Operating Instructions

## CHILD LOCK

You may lock the control panel to prevent the microwave from being accidentally started or used by children.

The Child Lock feature is also useful when cleaning the control panel. Child Lock prevents accidental programming when wiping the control panel.

**Example: To set the child lock.**

Enter  
Start

Touch and hold **ENTER/START** pad more than **3** seconds. **CHILD LOCK ON** will appear in the display window with one beep.

**Example: To cancel the child lock.**

Enter  
Start

Touch and hold **ENTER/START** pad more than **3** seconds. **LOCKED** will disappear and you hear one beep.

## LIGHT HI/LO/OFF

Light  
Hi/Lo/Off

Touch **LIGHT HI/LO/OFF** pad once for bright light, twice for night light, or three times to turn the light off.

## ADD 30 SEC.

A time-saving pad, this simplified control lets you quickly set and start microwave cooking without the need to touch the **ENTER/START** pad.

**Example: To set ADD 30 SEC. for 2 minutes.**

Add  
30 Sec.

Touch **ADD 30 SEC.** pad 4 times. The oven begins cooking and display shows time counting down.

## LIGHT TIMER

You can set the LIGHT to turn on and off automatically at any time. The light comes on at the same time every day until reset.

**Example: Turn on 2:00 AM, turn off 7:00 PM.**

**12 hour clock mode.**

Light  
Timer

2 0 0  
200°F 450°F 450°F

Enter  
Start

1  
Less  
100°F

Enter  
Start

7 0 0  
375°F 450°F 450°F

Enter  
Start

2  
200°F

Enter  
Start

1. Touch **LIGHT TIMER** pad.
2. Enter the time you want the LIGHT to turn on.
3. Touch **ENTER/START** pad .
4. Touch **1** for AM.
5. Touch **ENTER/START** pad.
6. Enter the time you want the LIGHT to turn off.
7. Touch **ENTER/START** pad.
8. Touch **2** for PM.
9. Touch **ENTER/START** pad.

**24 hour clock mode.**

Light  
Timer

2 0 0  
200°F 450°F 450°F

Enter  
Start

1 Less More  
100°F 425°F 450°F 450°F

Enter  
Start

1. Touch **LIGHT TIMER** pad.
2. Enter the time you want the LIGHT to turn on.
3. Touch **ENTER/START** pad .
4. Enter the time you want the LIGHT to turn off.
5. Touch **ENTER/START** pad.

**Example: To cancel the LIGHT TIMER.**

Light  
Timer

0  
450°F

1. Touch **LIGHT TIMER** pad.
2. Touch **0** pad.

## MORE/LESS

The **More(9)/Less(1)** pads allow you to adjust pre-set cooking times. They only work in the Sensor Reheat, Sensor Cooking(except Beverage), Add 30 sec, Custom Cook or Time Cook modes. Use the **More(9)/Less(1)** pads only after you have already begun cooking with one of these procedures.

More  
9  
425°F

1  
Less  
100°F

1. To ADD more time to an automatic cooking procedure: Touch the **More(9)** pad.
2. To REDUCE the time of an automatic cooking procedure: Touch the **Less(1)** pad.

# Operating Instructions

## COOKING AT HIGH POWER LEVELS

**Example: To cook food for 8 minutes 30 seconds at 100% power.**

8 3 0  
400°F 250°F 450°F

Enter  
Start

1. Enter the cook time.
2. Touch **ENTER/START** pad.

When the cook time is over, you will hear four beeps and **END** will display.

## COOKING AT LOWER POWER LEVELS

HIGH power cooking does not always give you the best results with foods that need slower cooking, such as roasts, baked goods, or custards. Your oven has 9 power settings in addition to HIGH.

**Example: To cook food for 7 minutes 30 seconds at 70% power.**

7 3 0  
375°F 250°F 450°F

Power  
Level

7  
375°F

Enter  
Start

1. Enter the cook time.
2. Touch **POWER LEVEL** pad.
3. Enter the power level.
4. Touch **ENTER/START** pad.

When the cook time is over, you will hear four beeps and **END** will display.

See cooking guide for Power levels, page 12.

### IMPORTANT:

- **DO NOT** store or use the wire rack in this oven unless more than one item is being cooked or a recipe calls for it.
- Damage to the oven could occur

## COOKING WITH MORE THAN ONE COOK CYCLE

For best results, some recipes call for one Power Level for a certain length of time, and another Power Level for another length of time. Your oven can be set to change from one to another automatically, for up to three cycles if the first cycle is defrost.

**Example: To cook food for 3 minutes at 90% power and then 70% power for 7 minutes 30 seconds.**

3 0 0  
250°F 450°F 450°F

Power  
Level

More  
9  
425°F

7 3 0  
375°F 250°F 450°F

Power  
Level

7  
375°F

Enter  
Start

1. Enter the first cook time.
2. Touch **POWER LEVEL** pad.
3. Enter the power level.
4. Enter the second cook time.
5. Touch **POWER LEVEL** pad.
6. Enter the power level.
7. Touch **ENTER/START** pad.

When the cook time is over, you will hear four beeps and **END** will display.

# Operating Instructions

## COOKING GUIDE FOR POWER LEVELS

The 9 power levels in addition to HIGH allow you to choose the best power level for the food you are cooking. Below are listed all the power levels, examples of foods best cooked at each level, and the amount of microwave power you are using.

POWER LEVEL	MICROWAVE OUTPUT	USE
10 High	100%	<ul style="list-style-type: none"> <li>• Boil water.</li> <li>• Cook ground beef.</li> <li>• Make candy.</li> <li>• Cook fresh fruits and vegetables.</li> <li>• To begin cooking meat, fish and poultry.</li> <li>• Preheat browning dish.</li> <li>• Reheat beverages.</li> <li>• Bacon slices.</li> </ul>
9	90%	<ul style="list-style-type: none"> <li>• Reheat meat slices quickly.</li> <li>• Saute onions, celery, and green pepper.</li> </ul>
8	80%	<ul style="list-style-type: none"> <li>• All reheating.</li> <li>• Cook scrambled eggs.</li> </ul>
7	70%	<ul style="list-style-type: none"> <li>• To continue cooking poultry.</li> <li>• Cook breads and cereal products.</li> <li>• Cook cheese dishes, veal, seafood.</li> <li>• Cook cakes, muffins, brownies, cupcakes.</li> </ul>
6	60%	<ul style="list-style-type: none"> <li>• Cook pasta.</li> </ul>
5	50%	<ul style="list-style-type: none"> <li>• To continue cooking meat.</li> <li>• Cook custard.</li> <li>• Cook whole chicken, turkey, spare ribs, rib roast, sirloin roast.</li> </ul>
4	40%	<ul style="list-style-type: none"> <li>• Cook less tender cuts of meat.</li> <li>• Reheat frozen convenience foods.</li> </ul>
3	30%	<ul style="list-style-type: none"> <li>• Thaw meat, poultry, and seafood.</li> <li>• Cook small quantities of food.</li> <li>• Finish cooking casserole, stew, and some sauces.</li> </ul>
2	20%	<ul style="list-style-type: none"> <li>• Soften butter and cream cheese.</li> <li>• Heat small amounts of food.</li> </ul>
1	10%	<ul style="list-style-type: none"> <li>• Soften ice cream.</li> <li>• Raise yeast dough.</li> </ul>

# Operating Instructions

## SENSOR OPERATING INSTRUCTIONS

Sensor Cook allows you to cook most of your favorite foods without selecting cooking times and power levels. The display will indicate the sensing period by scrolling the name of the food. The oven automatically determines required cooking time for each food item. When the internal sensor detects a certain amount of humidity coming from the food, it will tell the oven how much longer to cook. The display will show the remaining cooking time.

For best results when cooking by Sensor, follow these recommendations:

1. Food cooked with the sensor system should be at normal storage temperature.
2. Glass turntable and outside of container should be dry to assure best cooking results.
3. Most foods should be covered loosely with microwavable plastic wrap, waxed paper, or a lid.
4. Do not open the door or touch the **STOP/CLEAR** pad during the sensing time. When sensing time is over, the oven beeps and the remaining cooking time will appear in the display window. At this time you can open the door to stir, turn, or rearrange the food.

### IMPORTANT:

When using sensor cook, the oven must cool for 5 minutes between uses or food will not cook properly.

## SENSOR COOKING GUIDE

Appropriate containers and coverings help assure good Sensor cooking results.

1. Always use microwavable containers and cover them with lids or vented plastic wrap.
2. Never use tight-sealing plastic covers. They can prevent steam from escaping and cause food to overcook.

3. Match the amount to the size of the container. Fill containers at least half full for best results.
4. Be sure the outside of the cooking container and the inside of the microwave oven are dry before placing food in the oven. Beads of moisture turning into steam can mislead the sensor.

## ADDING OR SUBTRACTING COOK TIME

By using the **More(9)** or **Less(1)** pads all of the sensor cook and time cook settings can be adjusted to cook food for a longer or shorter time.

### CAUTION

- **DO NOT** leave microwave oven unattended while popping corn.
- When popping commercially packaged popcorn, **remove the shelf from the oven; Do not** place the bag of microwave popcorn on the shelf or under the shelf.

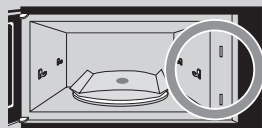
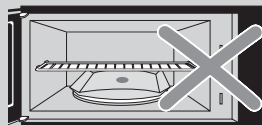
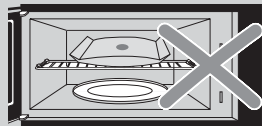

## POPCORN

POPCORN pad lets you pop commercial-ly packaged microwave popcorn. Pop only one package at a time. For best results, use fresh bags of popcorn.

**Example: To pop popcorn.**

Popcorn

Touch **POPCORN** pad.

When the cook time is over, you will hear four beeps and **END** will display.

- Recommended amounts:  
3.0-3.5 ozs.

## PIZZA SLICE

Reheating pizza with **PIZZA SLICE** pad lets you reheat one or several slices of pizza without selecting cooking times and power levels.

**Example: To reheat 2 slices of pizza.**

Pizza  
Slice

Touch **PIZZA SLICE** pad.

When the cook time is over, you will hear four beeps and **END** will display.

- Recommended amounts: 1-4 slices.

### NOTE:

If food is not thoroughly cooked or reheated when using the sensor feature, complete using a power level and cooking time. **DO NOT** continue using the sensor pad.

# Operating Instructions

## BAKED POTATO

The **BAKED POTATO** pad lets you bake one to six potatoes without selecting cooking times and power levels.

### NOTES:

- Cooking time is based on a 6-8 oz. potato.
- Use the **More(9)/Less(1)** pads if cooking larger or smaller potatoes.
- Before baking, pierce potato with fork several times.
- If potato are not completely cooked, continue cooking using Cooking Time.
- **DO NOT** use **BAKED POTATO** pad to complete cooking.

After baking, let stand for 5 minutes.

**Example: To cook 2 potatoes.**

Baked  
Potato

Touch **BAKED  
POTATO** pad.

When the cook time is over, you will hear four beeps and **END** will display. Recommended amounts: 1-6 potatoes.

## SENSOR COOK

Using **SENSOR COOK** pad lets you heat common microwave-prepared foods without needing to program cooking times and power levels. **SENSOR COOK** has 5 preset food categories: **Frozen Vegetable, Frozen Breakfast, Frozen Dinner, Fresh Vegetable.**

**Example: To cook Frozen Dinner.**

Cook

1. Touch **SENSOR  
COOK** pad.

3  
250°F

2. Choose food category. (1-5)

Category	Touch Pad Number
Frozen Vegetable	1
Frozen Breakfast	2
Frozen Dinner	3
Fresh Vegetable	4
Shrimp	5

When the cook time is over, you will hear four beeps and **END** will display.

### Recommended amounts:

Frozen Vegetable	1-4 Servings
Frozen Breakfast	4-8 ozs.
Frozen Dinner	8-14 ozs.
Fresh Vegetable	1-4 Servings
Shrimp	8-32 ozs.

## REHEAT

**REHEAT** pad lets you heat foods without needing to program cooking times and power levels. **REHEAT** has 3 preset categories: Dinner Plate, Casserole, and Pasta.

**Example: To reheat Casserole.**

Reheat

1. Touch **REHEAT** pad.

2  
200°F

2. Choose food category (1-3).

Category	Touch Pad Number
Dinner Plate	1
Casserole	2
Pasta	3

When the cook time is over, you will hear four beeps and **END** will display.

### Recommended amounts:

Dinner Plate	1 serving
Casserole	1-4 servings
Pasta	1-4 servings

# Operating Instructions

## SENSOR COOK TABLE

CATEGORY		DIRECTIONS	AMOUNT
Popcorn		Use only one microwave-only bag of popcorn at a time. Use caution when removing and opening the hot bag from oven. Let oven cool for at least 5 minutes before using again.	3.0 to 3.5 oz 1 package
Baked Potato		Prick each potato several times with fork. Place on turntable in spoke-like fashion. Let stand 3-5 minutes. Turn over during countdown time. Let oven cool for at least 5 minutes before using again. Use <b>More(9)</b> pad when cooking larger potatoes.	1 to 6 potatoes
Pizza Slice		Put 1-3 slices of pizza on a Microwave-safe plate with wide end of slice toward the outside edge of the plate. Do not let slices overlap. Do not cover. Let oven cool for at least 5 minutes before using again. Use <b>More(9)</b> pad to increase reheat time for thick crust pizza.	1 to 4 slices
COOK	Frozen Vegetables	Place frozen vegetables in microwave-safe ceramic, glass or plastic dish and add 2-4 Tbs. water. Cover with lid or vented plastic wrap during cooking and stir before standing. Let oven cool for at least 5 minutes before using again. Use the <b>More(9)</b> pad when cooking dense vegetables such as carrots or broccoli spears.	1 to 4 servings
	Frozen Breakfast	Follow package instructions for covering and standing. Use this pad for frozen sandwich, breakfast entree, etc. Let oven cool for at least 5 minutes before using again.	4 to 8 oz.
	Frozen Dinner	Remove food from outer wrapping and follow box instructions for covering and standing. Let oven cool for at least 5 minutes before using again.	8 to 14 oz.
	Fresh Vegetables	Place fresh vegetables in microwave-safe ceramic, glass or plastic dish and add 2-4 Tbs. water. Cover with lid or vented plastic wrap during cooking and stir before standing. Let oven cool for at least 5 minutes before using again. Use the <b>More(9)</b> pad when cooking dense vegetables such as carrots or broccoli spears.	1 to 4 servings
	Shrimp	Arrange shrimp in a microwave-safe ceramic glass or plastic dish and add 2-4 Tbs melted butter. Cover with lid or vented plastic wrap during cooking and stir before serving. Let stand 3 minutes. Let oven cool at least 5 minutes before using again.	8 to 32 oz.

## SENSOR REHEAT TABLE

CATEGORY		DIRECTIONS	AMOUNT
Dinner Plate		Use only pre-cooked, refrigerated foods. Cover plate with vented plastic wrap or waxed paper, tucked under plate. If food is not as hot as you prefer after heating with REHEAT, continue heating using cooking time and power level. Do not continue cooking using the <b>Reheat</b> pad. Contents: - 3-4 oz. meat, poultry or fish (up to 6 oz. with bone) - 1/2 cup starch (potatoes, pasta, rice, etc.) - 1/2 cup vegetables (about 3-4 oz.)	1 serving (1 plate)
Casserole		Cover plate with lid or vented plastic wrap. If food is not as hot as you prefer after heating with REHEAT, continue heating using cooking time and power level. Do not continue cooking using the <b>Reheat</b> pad.	1 to 4 servings
Pasta		Stir foods once before serving. Contents: - Casserole-refrigerated foods. (Examples: Lasagna and beef stew.) - Pasta-Canned spaghetti and ravioli, refrigerated foods.	

### NOTE:

Desired food temperature varies from person to person. Use the **More(9)/Less(1)** pads to fit your temperature preference.



# Operating Instructions

## AUTO COOK

**AUTO COOK** pad provides five preset categories for cooking.

**Example: To Cook 2.5 ozs. of baby food.**

1. Touch **AUTO COOK** pad once.
2. Choose food category (1-5).
3. Enter the serving size (1-3).
4. Touch **ENTER/START** pad.

Category	Touch pad number
Baby Food	1
Beverage	2
Frozen Sandwich	3
Bacon	4
Instant Rice	5

When the cook time is over, you will hear four beeps and **End** will display.

## AUTO COOK TABLE

CATEGORY	DIRECTIONS	AMOUNT
Baby Food	Remove lid from baby food and place in the center of oven. Check temperature and stir well before serving. The <b>More(9)/Less(1)</b> pads cannot be used with the baby food. Follow manufacturer's instructions, some baby food should not be heated in the microwave oven.	2.5, 4, 6 ozs.
Beverage	Use measuring cup or mug; do not cover. Place the beverage in the oven. After heating, stir well. Let oven cool for at least 5 minutes before using again. Note: • Reheat times based on an 8 ounce cup. • Beverage heated with the beverage feature may be very hot. • Remove container with care.	0.5 cup 1 cup 2 cups
Frozen Sandwich	Place frozen sandwich in susceptor "sleeve" (which is in package) and put on plate.	1, 2 EA
Bacon	Place 2 paper towels on plate and arrange bacon on towels, do not overlap. Cover with additional paper towel. Remove paper towel immediately after cooking. Use <b>More(9)/Less(1)</b> pads for desired crispness.	2, 4, 6 slices
Instant Rice	Follow microwave package preparation instructions. Use a large microwave-safe cookware to prevent boilovers.	2, 4 servings

**NOTE:**

Desired food temperature varies from person to person. Use the **More(9)/Less(1)** pads to fit your temperature preference.

# Operating Instructions

## AUTO DEFROST

Defrost choices are preset in the oven. The defrost feature provides you with the best defrosting method for frozen foods, because the oven automatically sets the defrosting times according to the weight you enter. For added convenience, the AUTO DEFROST beeps to remind you to check or turn over the food during the defrost cycle. After touching the AUTO DEFROST pad once, select the type of food, then enter the food weight.

**Example: To defrost 1.8 lbs of meat.**

1. Touch **AUTO DEFROST** pad.
2. Touch 1 pad to select meat.
3. Enter the weight.
4. Touch **ENTER/START** pad.

Auto Defrost

1 Less 100°F

1 Less 8 100°F 400°F

Enter Start

### NOTES:

- After you touch **ENTER/START** pad, the display counts down the defrost time. The oven will beep twice during the Defrost cycle. At this time, open the door and turn the food as needed. Remove any portions that have thawed or separate pieces then return frozen portions to the oven and touch **ENTER/START** pad to resume the defrost cycle.
- **The oven will not stop during the BEEP unless the door is opened.**

## DEFROSTING GUIDE

- Follow the instructions below when defrosting different types of food.

Touch pad No.	Food	Standard Amount	Procedure
1	<b>MEAT</b>	2.5-6.0 lbs.	Start with the food placed fat side down. After each stage, turn the food over and shield any warm portions with narrow strips of aluminum foil. Let stand, covered, for 15 to 30 minutes.
2	<b>POULTRY</b>	0.5-3.0 lbs.	After each stage, separate and rearrange the food. If there are any warm or thawed portions of food, shield them with narrow flat pieces of aluminum foil. Remove any pieces of food that are nearly defrosted. Let stand, covered, for 5-10 minutes.

Touch pad No.	Food	Standard Amount	Procedure
3	<b>FISH</b>	0.5-3.0 lbs.	After each stage, rearrange the food. If there are any warm portions of food, shield them with narrow flat pieces of aluminum foil. Remove any pieces of food that are nearly defrosted. Let stand, covered, for 5-10 minutes.
4	<b>BREAD</b>	0.1-2.0 lbs.	Arrange rolls in a circle horizontally on paper towels in the middle of turntable. Turn over after half of defrosting time.
5	<b>GROUND BEEF</b>	1.0 lb.	After each stage, remove any pieces of food that are nearly defrosted. Let stand, covered with foil for 5-10 minutes.

## DEFROST TIPS

- When using AUTO DEFROST, the weight to be entered is the net weight in pounds and tenths of pounds (the weight of the food minus the container).
- Use AUTO DEFROST only for raw food. AUTO DEFROST gives best results when food to be thawed is a minimum of 0°F (taken directly from a true freezer). If food has been stored in a refrigerator-freezer that does not maintain a temperature of 5°F or below, always program a lower food weight (for a shorter defrosting time) to prevent cooking the food.
- If the food is stored outside the freezer for up to 20 minutes, enter a lower food weight.
- The shape of the package alters the defrosting time. Shallow rectangular packets defrost more quickly than a deep block.
- Separate pieces as they begin to defrost. Separated pieces defrost more easily.
- Shield areas of food with small pieces of foil if they start to become warm.
- You can use small pieces of aluminum foil to shield foods like chicken wings, leg tips, and fish tails, but the foil must not touch the side of the oven. Foil causes arcing, which can damage the oven lining.

# Operating Instructions

## SNACKS

SNACKS lets you heat 4 categories of food: **Nachos, Chicken Wings, Potato Skins, and Cheese Sticks.**

**Example: To cook nachos.**

**Snacks**

1 Less  
100°F

Enter  
Start

1. Touch **SNACKS** pad.
2. Choose food category(1-4).
3. Touch **ENTER/START** pad.

Category	Touch Pad Number
Nachos	1
Chicken Wings	2
Potato Skins	3
Cheese Sticks	4

## SNACKS CHART

Item	Amount or servings	Remarks
Nachos	1 serving	<ul style="list-style-type: none"> <li>Place tortilla chips on plate without overlapping.</li> <li>Sprinkle evenly with cheese.</li> <li>Contents:                             <ul style="list-style-type: none"> <li>- 2 cups tortilla chips</li> <li>- 1/3 cup grated cheese</li> </ul> </li> </ul>
Chicken Wings	5-6 oz. 7-8 oz.	<ul style="list-style-type: none"> <li>Use pre-cooked, refrigerated chicken wings.</li> <li>Place chicken wings around plate in spoke fashion and cover with wax paper.</li> </ul>
Potato Skins	1 cooked potato 2 cooked potatoes	<ul style="list-style-type: none"> <li>Cut cooked potato into 4 even wedges. Scoop or cut out potato flesh, leaving about 1/4" of skin.</li> <li>Place skins in spoke fashion around plate.</li> <li>Sprinkle with bacon, onions and cheese. Do not cover.</li> </ul>
Cheese Sticks	5-7 pcs. 8-10 pcs.	<ul style="list-style-type: none"> <li>Place cheese sticks on plate in spoke fashion.</li> <li>Do not cover.</li> </ul>

# Operating Instructions

## SOFTEN/MELT

SOFTEN/MELT lets you soften or melt 3 categories of food: **Melt Chocolate, Soften Cream Cheese and Melt Butter.**

**Example: To melt chocolate.**



1. Touch **SOFTEN/MELT** pad.
2. Choose food category(1-3).
3. Touch **ENTER/START** pad.

Category	Touch Pad Number
Melt Chocolate	1
Soften Cream Cheese	2
Melt Butter	3

## SOFTEN/MELT CHART

Item	Amount or servings	Remarks
Melt Chocolate	1 cup chips	<ul style="list-style-type: none"> <li>• Place chocolate chips in a microwave-safe dish.</li> <li>• Stir well at half time when the oven beeps, and re-start the oven.</li> <li>• Unless stirred, the chocolate keeps its shape even when heating time is over.</li> </ul>
Soften Cream Cheese	1 package (8 oz.)	<ul style="list-style-type: none"> <li>• Unwrap cream cheese and place on microwave-safe dish.</li> <li>• Let stand 1-2 minutes.</li> </ul>
Melt Butter	1 stick (1/4 lb.)	<ul style="list-style-type: none"> <li>• Remove wrapping and cut butter in half vertically.</li> </ul>
	2 sticks (1/2 lb.)	<ul style="list-style-type: none"> <li>• Place butter in dish, cover with wax paper.</li> <li>• Stir well after finishing and let stand 1-2 minutes.</li> </ul>

# Operating Instructions

## MICRO/CONVECT

This oven can cook food without entering cooking time or power level using MICRO/CONVECT.

**MICRO/CONVECT** has 4 food categories: Whole Chicken, Roast Pork, Frozen Lasagna, Baked Potatoes.

See the **MICRO/CONVECT CHART** on this page for the settings available.

**Example: To cook 2 lbs. roast pork.**

Micro  
Convect

1. Touch **MICRO/CONVECT** pad.

2  
200°F

2. Choose food category.

2 0  
200°F 450°F

3. Touch number pads for food quantity.

Enter  
Start

4. Touch **ENTER/START** pad.

## MICRO/CONVECT TABLE

CATEGORY	TOUCH PAD	WEIGHT	RACK SIZE	COMMENTS
Whole Chicken	1	2.0-4.0 lbs.	Place drip pan on glass turntable. Place food on rack directly above drip pan.	Fold chicken wings under the chicken. Brush with melted butter. Place chicken, breast side down on rack. When oven beeps, turn chicken over and restart oven. Let stand 5 minutes.
Roast Pork, Boneless Tenderloin	2	2.0-4.0 lbs.	Place drip pan on glass turntable. Place food on rack directly above drip pan.	Place pork on rack. When oven beeps, turn roast over and restart oven. Let stand 5 minutes.
Frozen Lasagna	3	10 oz. or 21 oz.	Place food on rack.	Place lasagna on rack. Let stand 3 to 5 minutes.
Baked Potatoes	4	1-4 potatoes	Place potatoes on glass turntable.	Place potatoes on glass turntable. When oven beeps, turn potatoes over and restart oven. Let stand 5 minutes.

### NOTE:

When checking food for doneness during cooking, carefully remove food, rack and drip tray (if used) from the oven and close oven door to prevent excessive heat loss.

# Operating Instructions

## CONVECTION COOKING

During convection cooking, a heating element is used to raise the temperature of the air inside the oven. Convection cooking temperature ranges from 100°F to 450°F. It is best to preheat the oven when convection cooking.

**Lower oven temperature by 25°F from package recommended temperature instructions if lighter serving is preferred. The baking time may vary according to the food condition or individual preference. Check doneness at the minimum time and then adjust time by touching the More(9) or Less(1) pad.**

### CAUTION

- To avoid risk of burns, handle utensils, racks, and door with care. Allow oven, utensils, and racks to cool before cleaning. Oven, utensils, and racks, become hot during operation.
- To avoid risk of personal injury or property damage, do not use oven without turntable in place.
- To avoid risk of personal injury or property damage, do not cover turntable or rack with aluminum foil.
- To avoid risk of property damage, do not use lightweight plastic containers, plastic wraps or paper products during a convection cooking cycle.
- **Do Not** touch hot surfaces (Including oven cavity, oven door, turntable, rack or pan; use pot holder).

## RACK

Use the rack for convection, combination cooking and microwave mode.

For best results, place food on the rack.



**RACK**

## DRIP PAN

A ceramic enamel drip pan has been included with your oven. When roasting in the oven, place food directly rack. Center the drip pan on the glass turntable under the food. When cooking is complete, use potholders to remove the drip pan from the hot oven. **Take care not to spill the hot drippings.** Remove food from the rack, then remove rack from the oven.

**Do not use in microwave-only mode.**

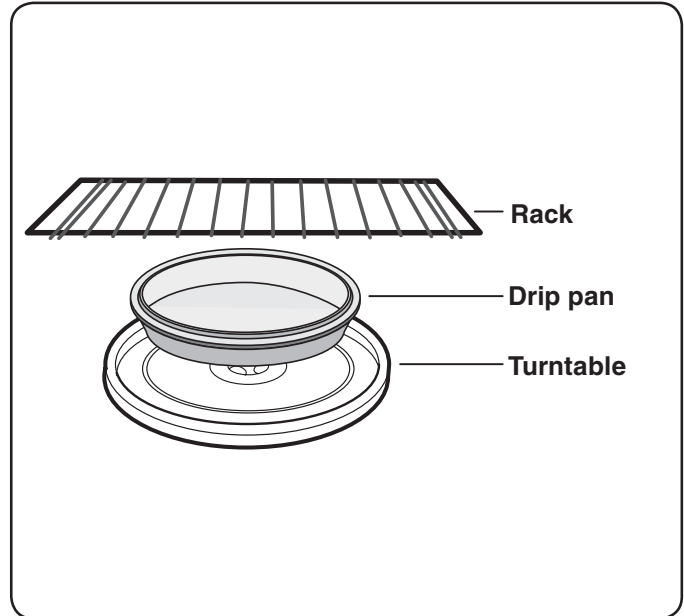

### IMPORTANT:

- **DO NOT** store or use the rack in this oven unless more than one item is being cooked, or a recipe calls for it.
- Damage to the oven could occur.

# Operating Instructions

## CONVECTION BAKING WITH PREHEATING

**Example: To set Convection Baking at 325°F. Use drip pan if cooking meats or poultry on the rack.**

Convection

1. Touch **CONVECTION** pad.

5  
325°F

2. Touch a number pad to select baking temperature.

Enter  
Start

3. Touch **ENTER/START** pad **twice**.

- After preheating, display scrolls **PLACE FOOD ON RACK** with sound. Open the door, place food on the convection rack.

2000  
200°F450°F450°F450°F

4. Touch number pads for cooking time. You can enter a time up to 99 minutes 99 seconds. See Convection baking Guide, page 23.

Enter  
Start

5. Open the door, put food in oven and close the door. Touch **ENTER/START** pad.

### NOTES:

- The oven temperature drops very quickly when the door is opened; however, this should not prevent food from being fully cooked during normal cooking time.
- When checking food for doneness during cooking, carefully remove food, rack and drip pad (if used) from the oven and close oven door to prevent excessive heat loss.

## CONVECTION BAKING WITHOUT PREHEATING

(Meats, Casseroles and Poultry)

**Example: To set Convection Baking at 325°F for 20 minutes. Use drip pan if cooking meats or poultry on the rack.**

Convection

1. Touch **CONVECTION** pad.

5  
325°F

2. Touch a number pad to select baking temperature. (You can enter a temperature between 100°F and 450°F.)

Enter  
Start

3. Touch **ENTER/START** pad **once**.

2000  
200°F450°F450°F450°F

4. Touch number pads for cooking time. You can enter a time up to 99 minutes 99 seconds.

Enter  
Start

5. Touch **ENTER/START** pad.

### IMPORTANT:

- If you set an incorrect cooking time, just re-enter the correct cooking time and then touch **ENTER/START** pad.
- If you touch **STOP/CLEAR** pad then enter the correct cooking time, you will cancel the CONVECTION operation and will be cooking with microwave energy and **NOT** convection.



# Operating Instructions

## CONVECTION BAKING GUIDE

1. Always use wire rack when convection baking. Place food directly on rack or place in drip pan and then place pan on rack.
2. Aluminum pans conduct heat quickly. For most convection baking, light, shiny finishes give best results because they prevent overbrowning in the time it takes to cook the center areas. Pans with dull (satin-finish) bottoms are recommended for cake pans and pie pans for vest bottom browning.
3. Dark or non-shiny finishes, glass, and pyroceram absorb heat which may result in dry, crisp crusts.
4. Preheating the oven is recommended when baking foods by convection. Meats, casseroles and poultry do not require preheating.
5. To prevent uneven heating and save energy, open the oven door to check food as little as possible.
6. ALWAYS remove rack from oven when microwaving.
7. Use a round metal pizza pan or a "Cookie sheet".

Food		Cook Time	Procedure
Breads	Yeast	Pan: Glass or metal loaf pan Temperature: 350°F Time: 40-50 min.	Shield top of loaf with foil if crust becomes too dark during baking. Cool 10 minutes before slicing.
	Quick	Pan: Glass or metal loaf pan Temperature: 350°F Time: 45-55 min.	Cool on rack 15 minutes before removing from pan.
Biscuits		Pan: 9" round or metal pizza pan Temperature: 375°F Time: 11-15 min.	Grease pan. Remove from pan immediately when cooked.
Cake	Angel Food	Pan: Metal tube pan Temperature: 350°F Time: 42-47 min.	<b>Do not</b> grease pan. Hang upside down (on narrow necked bottle) for 1 ½ hours to cool before removing from pan.
	Bundt	Pan: 12 cup Bundt pan Temperature: 350°F Time: 42-47 min.	Grease pan. Remove from pan after 10-15 minutes standing time.
	Layer	Pan: 8"-9" round or square Temperature: 350°F Time: 32-37 min.	Grease pan. Cake is done when toothpick comes out clean.
Cookies	Drop	Pan: Round pizza pan. Temperature: 350°F Time: 15-20 min.	Drop dough onto ungreased pan. Remove from oven when centers of cookies are still soft. Let stand on pan 1 minute before removing to cooling rack.
	Bar	Pan: 8" or 9" round or square pan Temperature: 350°F Time: 25-30 min.	Grease pan. Remove from oven when toothpick placed between edge and center comes out clean.
Cupcakes/Muffins		Pan: Six portion cupcake pan Temperature: 350°F Time: 15-20 min.	Grease cups or use paper liners. <b>DO NOT</b> use foil liners. Done when toothpick comes out clean.
Pies		Pan: Metal or glass pie dish. Temperature: 350°F Time: 45-55 min.	Remove from oven when filling is set and crust has browned.
Rolls		Pan: 8"-9" round pan or 12" pizza pan. Temperature: 375°F Time: 15-19 min.	Remove from pan immediately.

# Operating Instructions

## TIPS FOR COMBINATION COOKING

Combination cooking uses microwave energy and convection cooking to shorten cooking time.

This cooking process also leaves meats juicy on the inside and crispy on the outside. In combination cooking, the convection heat and microwave energy alternate automatically. combination cooking has one preprogrammed setting to make it easy to use.

## HELPFUL HINTS FOR COMBINATION COOKING

1. Meats may be roasted directly on the shelf.  
When using the shelf, please check your cooking guide for information on proper use. See page 25.
2. Less tender cuts of beef can be roasted and tenderized using oven cooking bags.

## PRECAUTIONS

1. All cookware used for combination cooking must be both microwave-safe and ovenproof.
2. **DO NOT** use metal cookware when using combination cooking. During combination baking, metal cookware may cause arcing when it comes in contact with the oven walls or metal accessory shelves. Arcing is a discharge of electricity that occurs when microwaves come in contact with metal.

## COMBINATION COOKING

Oven Temperature	Microwave power
Convection 425°F	30%

**Example: To combination cook for 45 minutes.**

Combination  
Cooking

1. Touch **COMBINATION COOKING** pad once.  
\* **ROAST ENTER COOKING TIME** will be displayed.

4 5 0 0  
300°F 325°F 450°F 450°F

2. Touch number pads to enter 45 minutes cooking time.  
(Oven will automatically cook at 30% power.)

Enter  
Start

3. Touch **ENTER/START** pad.

### NOTE:

- You can enter a time up to 99 minutes 99 seconds.
- When checking food for doneness during cooking, carefully remove food, rack and drip tray (if used) from the oven and close oven door to prevent excessive heat loss.

# Operating Instructions

## COMBINATION COOKING GUIDE

- When roasting meats and poultry, spray shelf with vegetable cooking spray. Place food directly on shelf in ceramic metal pan. Place pan on glass turntable.
- Set oven for maximum cooking time using **COMBI** pad. Set minimum cooking using **KITCHEN TIMER** pad.
- When using Combination cooking, multiply the weight of the meat by the minutes per pound, listed in the table below to figure your cooking time. After half the cooking time, turn the meat over, remove any accumulated drippings, return to the oven, and touch **ENTER/START** pad.
- Check doneness at minimum cooking time and continue cooking until done. Let stand 5 minutes before serving.

Food	Amount	Time, Min/lb.	
Beef Roast, boneless	3-6 lbs.	Well Done 170°F	20-22
		Medium 160°F	17-20
Pork Loin Roast, boneless	3-6 lbs.	Well Done 170°F	18-21
		Medium 160°F	16-18
Chicken, Whole	3-6 lbs.	Breast Meat - 170°F Leg/thigh - 185°F	12-15

# Operating Instructions

## RACK

### CAUTION

To avoid risk of property damage:

- **Do not** use rack to pop popcorn.
- Shelf must be on the four plastic supports when used.
- Use the rack only when cooking food on rack position.
- **Do not** cook with rack on floor of the oven.

The rack gives you extra space when cooking in more than one container at the same time.

#### To use rack:

1. Place rack securely in the four plastic supports.
  - Rack **MUST NOT** touch metal walls or back of microwave oven.
2. Place equal amounts of food both **ABOVE AND BELOW** rack.
  - Amount of food must be approximately the same to balance out cooking energy.

#### IMPORTANT:

- **DO NOT** store or use the shelf in this oven unless more than one item is being cooked or a recipe calls for it.
- Damage to the oven could occur

# Operating Instructions

## COOKING GUIDE

### Guide for Cooking Meat in Your Microwave

- Place meat on a microwave-safe roasting rack in a microwave-safe dish.
- Start meat fat-side down. Use narrow strips of aluminum foil to shield any bone tips or thin meat areas.
- Check the temperature in several places before letting the meat stand the recommended time.
- The following temperatures are removal temperatures. The temperature of the food will rise during the standing time.

Food	Cook time	Power level	Directions
<b>Roast Beef Boneless (Up to 4 lbs.)</b>	7-11 min./lb. for 145° F (Rare)	High(10) for first 5 minutes, then medium(5)	Place roast fat-side down on roasting rack. Cover with wax paper. Turn over half way through cooking. Let stand 10 -15 minutes.
	8-12 min./lb. for 160° F (Medium)		
	9-14 min./lb. for 170° F (Well Done)		
<b>Pork Boneless or bone-in (Up to 4 lbs.)</b>	11-15 min./lb. for 170° F (Well Done)	High(10) for first 5 minutes, then medium(5)	Place roast fat-side down on roasting rack. Cover with wax paper. Turn over half way through cooking. Let stand 10 -15 minutes.

- Expect a 10°F rise in temperature during the standing time.

Food		Remove from oven	After standing (10 -15 min.)
<b>Beef</b>	Rare	135°F	145°F
	Medium	150°F	160°F
	Well Done	160°F	170°F
<b>Pork</b>	Medium	150°F	160°F
	Well Done	160°F	170°F
<b>Poultry</b>	Dark meat	170°F	180°F
	Light meat	160°F	170°F

### Guide for Cooking Poultry in Your Microwave

- Place poultry on a microwave-safe roasting rack in a microwave-safe dish.
- Cover poultry with wax paper to prevent spattering.
- Use aluminum foil to shield bone tips, thin meat areas, or areas that start to overcook.
- Check the temperature in several places before letting the poultry stand the recommended time.

Food	Cook Time/Power Level	Directions
Whole Chicken Up to 4 lbs.	Cooking Time: 6-9 min. / lb. 180°F dark meat 170°F light meat Power Level: Medium High(7).	Place chicken breast-side down on roasting rack. Cover with wax paper. Turn over half way through cooking. Cook until juices run clear and meat near the bone is no longer pink. Let stand 5-10 minutes.
Chicken Pieces Up to 2 lbs.	Cooking Time: 6-9 min. / lb. 180°F dark meat 170°F light meat Power Level: Medium High(7).	Place chicken bone-side down on dish, with the thickest portions toward the outside of the dish. Cover with wax paper. Turn over half way through cooking. Cook until juices run clear and meat near the bone is no longer pink. Let stand 5-10 minutes.

# Operating Instructions

## Guide for Cooking Seafood in Your Microwave

- Cook fish until it flakes easily with a fork.
- Place fish on a microwave-safe roasting rack in a microwave-safe dish.
- Use a tight cover to steam fish. A lighter cover of wax paper or paper towel provides less steaming.
- Do not overcook fish; check it at minimum cooking time.

Food	Cook Time/Power Level	Directions
Steaks Up to 1.5 lbs.	Cooking Time: 6-10 min. / lb. Power Level: Medium-High(7).	Arrange steaks on roasting rack with meaty portions towards the outside of rack. Cover with wax paper. Turn over and rearrange when cooking time is half up. Cook until fish flakes easily with a fork. Let stand 3-5 minutes.
Fillets Up to 1.5 lbs.	Cooking Time: 3-7 min. / lb Power Level: Medium-High(7).	Arrange fillets in a baking dish, turning any thin pieces under. Cover with wax paper. If over ½ inch thick, turn over and rearrange when cooking time is half up. Cook until fish flakes easily with a fork. Let stand 2-3 minutes.
Shrimp Up to 1.5 lbs.	Cooking Time: 3-5 ½ min. / lb. Power Level: Medium-High(7).	Arrange shrimp in a baking dish without overlapping or layering. Cover with wax paper. Cook until firm and opaque, stirring 2 or 3 times. Let stand 5 minutes.

## Guide for Cooking Eggs in Your Microwave

- **Never** cook eggs in the shell, and never warm hard-cooked eggs in the shell; they can explode.
- Always pierce whole eggs to keep them from bursting.
- Cook eggs just until set; they become tough if overcooked.

## Guide for Cooking Vegetables in Your Microwave

- Vegetables should be washed just before cooking. Often, no extra water is needed. If dense vegetables such as potatoes, carrots and green beans are being cooked, add about ¼ cup water.
- Small vegetables (sliced carrots, peas, lima beans, etc.) will cook faster than larger ones.
- Whole vegetables, such as potatoes, acorn squash or corn on the cob, should be arranged in a circle on the turntable before cooking. They will cook more evenly if turned over after half the cooking time has passed.
- Always place vegetables like asparagus and broccoli with the stem ends pointing towards the edge of the dish and the tips toward the center.
- When cooking cut vegetables, always cover the dish with a lid or vented microwavable plastic wrap.
- Whole, unpeeled vegetables such as potatoes, squash, eggplant, etc., should have their skin pricked in several spots before cooking to prevent them from bursting.
- For more even cooking, stir or rearrange whole vegetables halfway through the cooking time.
- Generally, the denser the food, the longer the standing time. (Standing time refers to the time necessary for dense, large foods and vegetables to finish cooking after they come out of the oven.) A baked potato can stand on the counter for five minutes, while a dish of peas can be served immediately.

# Cooking Utensils

## MICROWAVE UTENSIL GUIDE

USE	DO NOT USE
<p><b>OVEN PROOF GLASS</b> (treated for high intensity heat): Utility dishes, loaf dishes, pie plates, cake plates, liquid measuring cups, casseroles and bowls without metallic trim.</p> <p><b>CHINA:</b> Bowls, cups, serving plates and platters without metallic trim.</p> <p><b>PLASTIC:</b> Plastic wrap (as a cover)-- lay the plastic wrap loosely over the dish and press it to the sides. Vent plastic wrap by turning back one edge slightly to allow excess steam to escape. The dish should be deep enough so that the plastic wrap will not touch the food. As the food heats it may melt the plastic wrap wherever the wrap touches the food. Use plastic dishes, cups, semirigid freezer containers and plastic bags <b>only for short cooking times. Use these with care because the plastic may soften from the heat of the food.</b></p> <p><b>PAPER:</b> Paper towels, waxed paper, paper napkins, and paper plates with no metallic trim or design. Look for the manufacturer's label for use in the microwave oven.</p>	<p><b>METAL UTENSILS:</b> Metal shields the food from microwave energy and produces uneven cooking. Also avoid metal skewers, thermometers or foil trays. Metal utensils can cause arcing, which can damage your microwave oven.</p> <p><b>METAL DECORATION:</b> Metal-trimmed or metal-banded dinnerware, casserole dishes, etc. The metal trim interferes with normal cooking and may damage the oven.</p> <p><b>ALUMINUM FOIL:</b> Avoid large sheets of aluminum foil because they hinder cooking and may cause harmful arcing. Use small pieces of foil to shield poultry legs and wings. Keep ALL aluminum foil at least 1 inch from the side walls and door of the oven.</p> <p><b>WOOD:</b> Wooden bowls and boards will dry out and may split or crack when you use them in the microwave oven. Baskets react in the same way.</p> <p><b>TIGHTLY COVERED UTENSILS:</b> Be sure to leave openings for steam to escape from covered utensils. Pierce plastic pouches of vegetables or other food items before cooking. Tightly closed pouches could explode.</p> <p><b>BROWN PAPER:</b> Avoid using brown paper bags. They absorb too much heat and could burn.</p> <p><b>FLAWED OR CHIPPED UTENSILS:</b> Any utensil that is cracked, flawed, or chipped may break in the oven.</p> <p><b>METAL TWIST TIES:</b> Remove metal twist ties from plastic or paper bags. They become hot and could cause a fire.</p>



# Care and Cleaning

## CARE AND CLEANING

For best performance and safety, keep the oven clean inside and outside. Take special care to keep the inner door panel and the oven front frame free of food or grease build-up.

### Never use rough powder or pads.

Wipe the microwave oven inside and out, including the hood bottom cover, with a soft cloth and a warm (not hot) mild detergent solution. Then rinse and wipe dry. Use a chrome cleaner and polish on chrome, metal and aluminum surfaces. Wipe spatters immediately with a wet paper towel, especially after cooking chicken or bacon. Clean your oven weekly or more often, if needed.

Follow these instructions to clean and care for your oven.

- Keep the inside of the oven clean. Food particles and spilled liquids can stick to the oven walls, causing the oven to work less efficiently.
- Wipe up spills immediately. Use a damp cloth and mild soap. Do not use harsh detergents or abrasives.
- To help loosen baked on food particles or liquids, heat two cups of water (add the juice of one lemon if you desire to keep the oven fresh) in a four-cup measuring glass at High power for five minutes or until boiling. Let stand in the oven for one or two minutes.
- Remove the glass tray from the oven when cleaning the oven or tray. To prevent the tray from breaking, handle it carefully and do not put it in water immediately after cooking. Wash the tray carefully in warm sudsy water or in the dishwasher.
- Clean the outside surface of the oven with soap and a damp cloth. Dry with a soft cloth. To prevent damage to the operating parts of the oven, don't let water seep into the openings.
- Wash the door window with very mild soap and water. Be sure to use a soft cloth to avoid scratching.

- If steam accumulates inside or outside the oven door, wipe with a soft cloth. Steam can accumulate when operating the oven in high humidity and in no way indicates microwave leakage.
- Never operate the oven without food in it; this can damage the magnetron tube or glass tray. You may wish to leave a cup of water in the oven when it is not in use to prevent damage if the oven is accidentally turned on.

## CONVECTION

### SHELF/DRIP PAN

Wash the convection shelf and ceramic enamel tray/drip pan with a mild soap and a soft or nylon scrub brush. Dry completely. Do not use abrasive scrubbers or cleaners to clean shelf and ceramic enamel tray/drip pan.

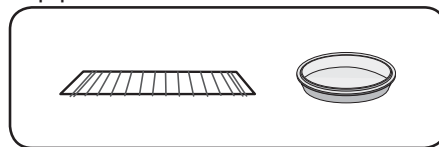

## CLEANING THE GREASE FILTER

The grease filter should be removed and cleaned often, at least once a month.

### CAUTION

To avoid risk of personal injury or property damage, do not operate oven hood without filters in place.

1. To remove grease filter, slide filter to the side. Pull filter downward and push to the other side. The filter will drop out.

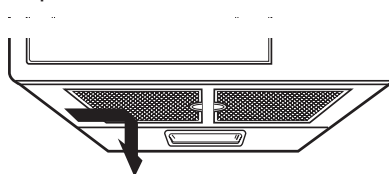

2. Soak grease filter in hot water and a mild detergent. Rinse well and shake to dry. **Do not use ammonia or place in a dishwasher. The aluminum will darken.**

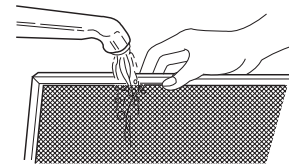

3. To reinstall the filter, slide it into the side slot, then push up and toward oven center to lock.

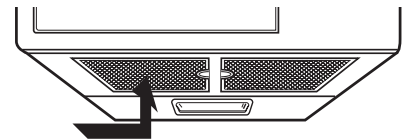

## CHARCOAL FILTER REPLACEMENT

If your oven is vented to the inside, the charcoal filter should be replaced every 6 to 12 months, and more often if necessary. The charcoal filter cannot be cleaned. To order a new charcoal filter, contact the Parts Department at your nearest Authorized Service Center or call **1-800-688-9900** (inside U.S.A) or **1-800-688-2002** (Canada).

1. Unplug oven or turn off power at the main power supply.
2. Open the door.
3. Remove the two vent grille mounting screws. (2 middle screws)

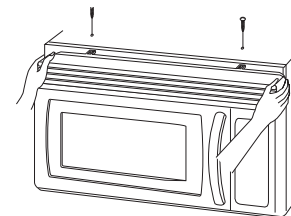

4. Slide the grille to the left, then pull straight out.
5. Remove old filter.

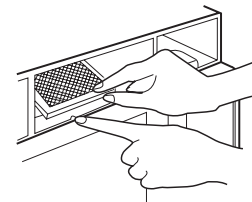

# Care and Cleaning

- Slide a new charcoal filter into place. The filter should rest at the angle shown.

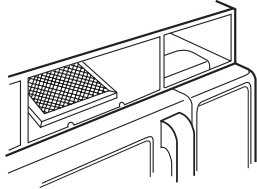

- Replace the mounting screws and close the door. Turn the power back on at the main power supply and set the clock.

CHARCOAL FILTER PART NO.  
8310P009-60

## COOKTOP/NIGHT LIGHT REPLACEMENT

### CAUTION

To avoid personal injury or property damage, wear gloves when replacing light bulb.

- Unplug the oven or turn off power at the main power supply.
- Remove the bulb cover mounting screws.
- Replace bulb with 20 watt appliance bulb.

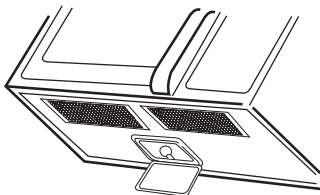

- Replace bulb cover, and mounting screws.
- Turn the power back on at the main power supply.

## OVEN LIGHT REPLACEMENT

- Unplug oven or turn off power at the main power supply.
- Open the door.
- Remove the vent cover mounting screws. (2 middle screws)
- Slide the grille to the left, then pull straight out.

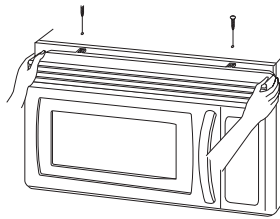

- Remove the screw located above the door near the center of the oven that secures the bulb holder.

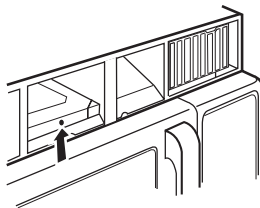

- Remove bulb holder.

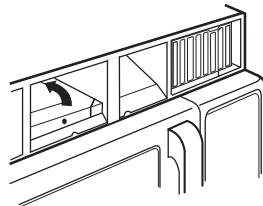

- Replace bulb with a 20 watt appliance bulb.
- Replace the bulb holder.
- Replace the grille and 2 screws. Turn the power back on at the main power supply.

## OPTIONAL

Filler Kits

**UXA3036BDB - BLACK**  
**UXA3036BDW - WHITE**  
**UXA3036BDS - STAINLESS**  
**STEEL**

When replacing a 36" range hood, the filler kit fills in the additional width to provide a custom built-in appearance.

For installation between cabinets only; not for end-of-cabinet installation.

Each kit contains two 3"-wide filler panels.

# Troubleshooting

## TROUBLESHOOTING GUIDE

**Before you call a repair person for your oven, check this list of possible problems and solutions.**

### **Neither the oven's display nor the oven operate.**

- Properly insert the plug into a grounded outlet.
- If the outlet is controlled by a wall switch, make sure the wall switch is turned on.
- Remove the plug from the outlet, wait ten seconds, then plug it in again.
- Reset the circuit breaker or replace any blown fuse.
- Plug another appliance into the outlet; if the other appliance doesn't work, have a qualified electrician repair the outlet.
- Plug the oven into a different outlet.

### **The oven's display works, but the power won't come on.**

- Make sure the door is closed securely.
- Check to see if packing material or other material is stuck to the door seal.
- Check for door damage.
- Press **STOP/CLEAR** pad twice and re-enter all cooking instructions.

### **The power goes off before the set time has elapsed.**

- If there has not been a power outage, remove the plug from the outlet, wait ten seconds, then plug it in again. If there was a power outage, the time indicator will display: **PLEASE TOUCH CLOCK AND SET TIME OF DAY.** Reset the clock and any cooking instructions.
- Reset the circuit breaker or replace any blown fuse.

### **The food is cooking too slowly.**

- Make sure the oven is on its own 20 amp circuit line. Operating another appliance on the same circuit can cause a voltage drop. If necessary, move the oven to its own circuit.

### **You see sparks or arcing.**

- Remove any metallic utensils, cookware, or metal ties. If using foil, use only narrow strips and allow at least one inch between the foil and interior oven walls.

### **The turntable makes noises or sticks.**

- Clean the turntable, roller ring and oven floor.
- Make sure the turntable and roller ring are positioned correctly.

### **Using your microwave causes TV or radio interference.**

- This is similar to the interference caused by other small appliances, such as hair dryers. Move your microwave further away from other appliances, like your TV or radio.

#### **Note:**

**If the oven is set to cook for more than 25 minutes, it will automatically adjust itself to 70 percent power after 25 minutes to avoid overcooking.**

**If you have a problem you cannot solve,  
please call our service line:  
(1-800-843-0304)**

# **Note**

---

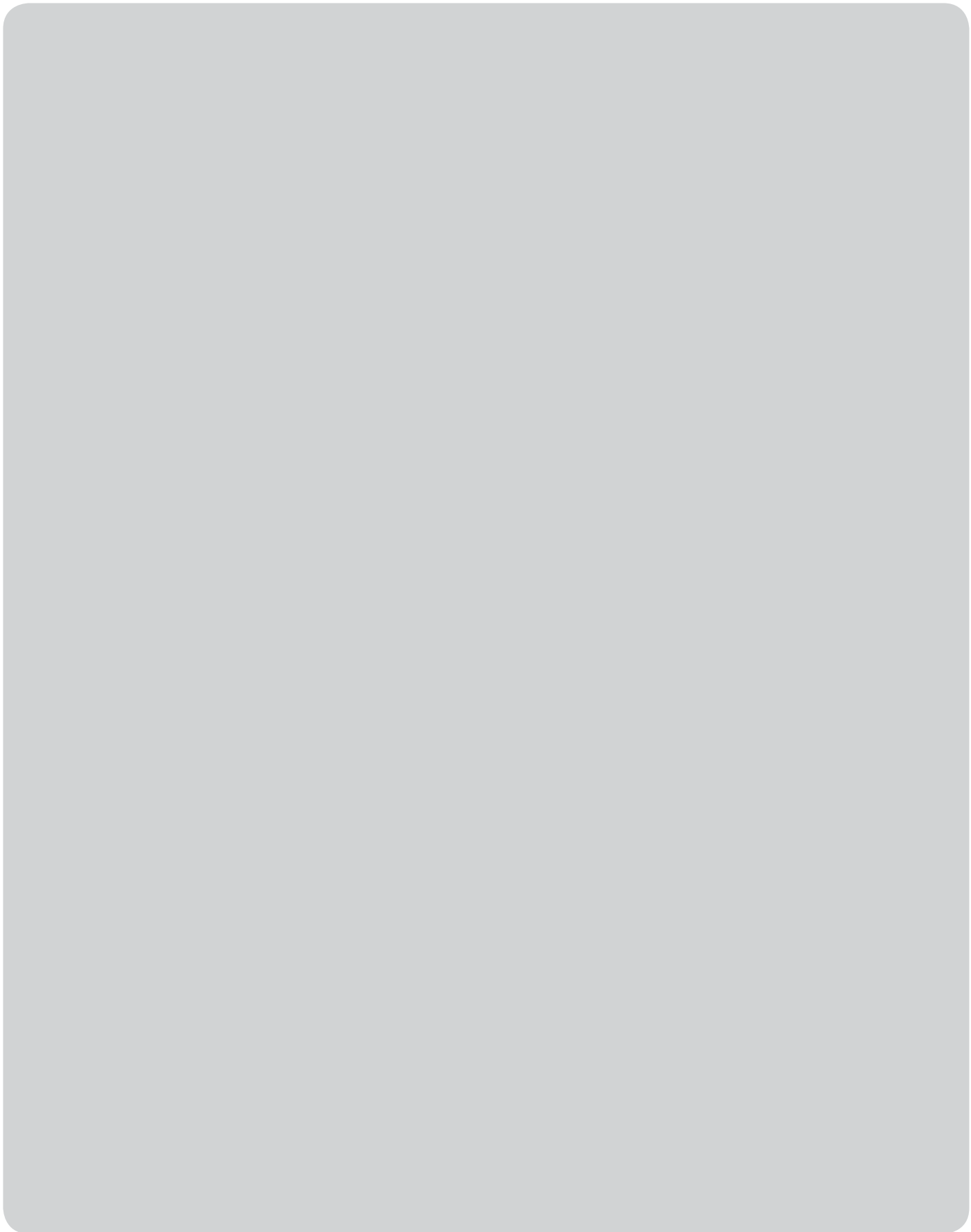

---

# AMANA® MAJOR APPLIANCE WARRANTY

---

## LIMITED WARRANTY

For one year from the date of purchase, when this major appliance is operated and maintained according to instructions attached to or furnished with the product, Amana brand of Whirlpool Corporation or Whirlpool Canada LP (hereafter "Amana") will pay for factory specified parts and repair labor to correct defects in materials or workmanship. Service must be provided by a Amana designated service company. This limited warranty is valid only in the United States or Canada and applies only when the major appliance is used in the country in which it was purchased. Outside the 50 United States and Canada, this limited warranty does not apply. Proof of original purchase date is required to obtain service under this limited warranty.

---

## ITEMS EXCLUDED FROM WARRANTY

**This limited warranty does not cover:**

1. Service calls to correct the installation of your major appliance, to instruct you on how to use your major appliance, to replace or repair house fuses, or to correct house wiring or plumbing.
2. Service calls to repair or replace appliance light bulbs, air filters or water filters. Consumable parts are excluded from warranty coverage.
3. Repairs when your major appliance is used for other than normal, single-family household use or when it is used in a manner that is contrary to published user or operator instructions and/or installation instructions.
4. Damage resulting from accident, alteration, misuse, abuse, fire, flood, acts of God, improper installation, installation not in accordance with electrical or plumbing codes, or use of consumables or cleaning products not approved by Amana.
5. Cosmetic damage, including scratches, dents, chips or other damage to the finish of your major appliance, unless such damage results from defects in materials or workmanship and is reported to Amana within 30 days from the date of purchase.
6. Any food loss due to refrigerator or freezer product failures.
7. Costs associated with the removal from your home of your major appliance for repairs. This major appliance is designed to be repaired in the home and only in-home service is covered by this warranty.
8. Repairs to parts or systems resulting from unauthorized modifications made to the appliance.
9. Expenses for travel and transportation for product service if your major appliance is located in a remote area where service by an authorized Amana servicer is not available.
10. The removal and reinstallation of your major appliance if it is installed in an inaccessible location or is not installed in accordance with published installation instructions.
11. Major appliances with original model/serial numbers that have been removed, altered or cannot be easily determined. This warranty is void if the factory applied serial number has been altered or removed from your major appliance.

The cost of repair or replacement under these excluded circumstances shall be borne by the customer.

---

## DISCLAIMER OF IMPLIED WARRANTIES; LIMITATION OF REMEDIES

CUSTOMER'S SOLE AND EXCLUSIVE REMEDY UNDER THIS LIMITED WARRANTY SHALL BE PRODUCT REPAIR AS PROVIDED HEREIN. IMPLIED WARRANTIES, INCLUDING WARRANTIES OF MERCHANTABILITY OR FITNESS FOR A PARTICULAR PURPOSE, ARE LIMITED TO ONE YEAR OR THE SHORTEST PERIOD ALLOWED BY LAW. AMANA SHALL NOT BE LIABLE FOR INCIDENTAL OR CONSEQUENTIAL DAMAGES. SOME STATES AND PROVINCES DO NOT ALLOW THE EXCLUSION OR LIMITATION OF INCIDENTAL OR CONSEQUENTIAL DAMAGES, OR LIMITATIONS ON THE DURATION OF IMPLIED WARRANTIES OF MERCHANTABILITY OR FITNESS, SO THESE EXCLUSIONS OR LIMITATIONS MAY NOT APPLY TO YOU. THIS WARRANTY GIVES YOU SPECIFIC LEGAL RIGHTS, AND YOU MAY ALSO HAVE OTHER RIGHTS WHICH VARY FROM STATE TO STATE OR PROVINCE TO PROVINCE.

---

If outside the 50 United States and Canada, contact your authorized Amana dealer to determine if another warranty applies.

If you need service, first see the "Troubleshooting" section of the Use & Care Guide. After checking "Troubleshooting," you may find additional help by checking the "Assistance or Service" section or by calling Amana. In the U.S.A., call **1-800-843-0304**. In Canada, call **1-800-807-6777**.